

HICONICS

A member of Midea group

User Manual for Balcony PV Products



COPYRIGHT © 2024 HICONICS ECO-ENERGY DRIVE TECHNOLOGY CO., LTD. ALL RIGHTS RESERVED.

Without a written permission of our company, any entity or individual shall not copy part or all of this document or upload it to any third-party platform such as a public network. In this case, any distribution form is not allowed.

TRADEMARK DECLARATION

Both Hiconics and other Hiconics trademarks belong to Hiconics Eco-energy Drive Technology Co., Ltd. We do not assume any liability or make any promise for anybody using them free of charge. All the other trademarks and registered trademarks mentioned in the document belong to their owners respectively.

CAUTION

The product, service, feature, etc. you have purchased is governed by a business contract or terms and conditions of Hiconics Eco-energy Drive Technology Co., Ltd. The product, service, or feature that you have purchased or are using may not be among the products, services, services, and features described in the document. Unless otherwise specified in the contract, Hiconics Eco-energy Drive Technology Co., Ltd. does not make any express or implied declaration or promise on the information in the document.

Due to product version upgrade or some other reason, the information in the document may be updated from time to time. If there is no special agreement, the information in the document cannot replace the safety precautions on the product label. All the descriptions in the document are used only as application guidance.

The illustrations and text in the document are carefully compiled. However, there is still a possibility that the document contains incorrect contents. We do not make any promise regarding this.

TABLE OF CONTENTS

- 1 Notes on this Manual 01**
 - 1.1 Scope of Validity 01
 - 1.2 Target Group 01
 - 1.3 Symbols Used 02
 - 1.4 EU Declarations of Conformity 02
 - 1.5 Release Notes 03

- 2 Safety 04**
 - 2.1 Notes on this Manual Explanation of Symbol 04
 - 2.2 Important Safety Instructions 05
 - 2.3 Handle Heavy Loads Safely 09

- 3 Introduction 11**
 - 3.1 Basic Features 11
 - 3.2 Typical Application Scenarios 12
 - 3.3 Packing Lists 13
 - 3.4 Product Appearance and Dimensions 15
 - 3.5 Interfaces 17

- 4 Installation 18**
 - 4.1 Check whether the product has any physical damage 18
 - 4.2 Product Installation 18
 - 4.3 Installation Procedure 20

- 5 Product Setting Procedure 36**
 - 5.1 Monitoring Platform Download 36
 - 5.2 Account Creation 36
 - 5.3 Plant Creation 37
 - 5.4 Logger Adding 37
 - 5.5 Network Configuration 38
 - 5.6 View Power Generation Status of Balcony PV System 38

- 6 Fault Information 39**

- 7 Packaging, Shipping, and Storage 41**

- 8 Parameter 42**

1 Notes on this Manual

1.1 Scope of Validity

This manual is an integral part of MCIV series balcony solar system, it describes the assembly, installation, commissioning, maintenance and failure of the product. Please read it carefully before operating.

Balcony Solar Package

MH-BPM-S0.8P0.8T1

MH-BPM-S0.8P0.8T2

Balcony solar package naming rules, for example: MH-BPM-S0.8P0.8T1

“MH” means “Midea Hiconics”

“BPM” means “Balcony Solar Package”

“S0.8P0.8T1” means “Silicon PV Module Package”

“S0.8P0.8T2” means “Flexible PV Module Package”

Microinverter

MH-MCIV0.8-SN

Microinverter naming rules, for example: MH-MCIV0.8-SN

“MH” means “Midea Hiconics”

“MCIV” means “Microinverter”

“0.8” means “0.8KW”

“SN” means “Single Phase”

It is recommended that this manual should be stored in a location that will be accessible at all times.

1.2 Target Group

This manual is for qualified electricians. The tasks described in this manual only can be performed by qualified electricians.

1.3 Symbols Used

The following types of safety instructions and general information appear in this document as described below:



Danger!

Indicates a hazard with a high level of risk which, if not avoided, will result in death or serious injury.



Warning!

Indicates a hazard with a medium level of risk which, if not avoided, could result in death or serious injury.



Caution

Indicates a hazard with a low level of risk which, if not avoided, could result in minor or moderate injury.



Notice

Indicates actions of which, if not avoided, could result in material damage.

1.4 EU Declarations of Conformity

HICONICS ECO-ENERGY DRIVE TECHNOLOGY CO., LTD. hereby declares that the inverter described in this document complies with the basic requirements and other relevant conditions of the directives listed below.

Directive 2014/53/EU

(on the harmonisation of the laws of the Member States relating to the making available on the market of radio equipment)

Directive 2014/30/EU

(on the approximation of the laws of the Member States relating to electromagnetic compatibility(EMC))

Directive 2014/35/EU

(on the harmonization of the laws of the Member States relating to the making available on the market of electrical equipment designed for use within certain voltage limits-in short: Low Voltage Directive)

Directive 2011/65/EU (RoHS)

(on the restriction of the use of certain hazardous substances in electrical and electronic equipment You will find a detailed EU Declaration of Conformity in the download area at: www.hiconics-global.com)

1.5 Release Notes

The version log accumulates the description of each document update, with the latest version covering all previous document versions.

V0.1 2024-05-21







First Release

2 Safety

2.1 Notes on this Manual Explanation of Symbol

This section gives an explanation of all the symbols shown on the inverter and on the type label.

Symbols on the Type Label

Symbol	Explanation
	CE mark. The inverter complies with the requirements of the applicable CE
	Beware of hot surface. The inverter will become hot during operation. Avoid touch it directly during operation. Danger of high temperature.
	Danger to life due to high voltages in the inverter!
	Danger Risk of electric shock!
	Please read the user manual carefully before operating the equipment.
	The system can't be disposed together with the household waste. Disposal information can be found in the enclosed documentation.
	Danger to life due to high voltage. There is residual voltage, which needs 5 min to discharge, existing in the inverter after powering off. Wait 5 min before you open the upper lid or the DC lid.

2.2 Important Safety Instructions



Danger!

Danger!

Danger to life due to high voltages in the inverter! All work must be carried out by qualified electrician. The appliance is not to be used by children or persons with reduced physical sensory or mental capabilities, or lack of experience and knowledge, unless they have been given supervision or instruction.



Caution

Caution!

Danger of burn injuries due to hot enclosure parts! During operation, the upper of the enclosure and the enclosure body may become hot. Only touch the lower enclosure lid during operation.



Caution

Caution!

Possible damage to health as result of the radiation! Do not stay closer than 20cm to inverter for any length of time.



Warning!

Warning!

Ensure input DC voltage \leq Max. DC voltage .Over voltage may cause permanent damage to inverter or other losses, which will not be included in warranty!



Warning!

Warning!

Risk of electric shock!



Warning!

Warning!

Authorized service personnel must disconnect both AC and DC power from inverter before attempting any maintenance or cleaning or working on any circuits connected to inverter.



Warning!

Warning!

Do not operate the inverter when the device is running.

- Prior to the application, please read this section carefully to ensure correct and safe application. Please keep the user manual properly.
- The accessories which are shipped with the inverter are only recommended, otherwise may result in a risk of fire, electric shock, or injury to person.
- Make sure that existing wiring is in good condition and that wire is not under-sized.
- Do not disassemble any parts of inverter which are not mentioned in installation guide. It contains no user-serviceable parts. See Warranty for instructions on obtaining service. Attempting to service the inverter yourself may result in a risk of electric shock or fire and will void your warranty.
- Keep away from flammable, explosive materials to avoid fire disaster.
- The installation place should be away from humid or corrosive substance.
- Authorized service personnel must use insulated tools when installing or working with this equipment.
- PV modules shall have an IEC 61730 class A rating. The microinverter utilizes strengthening insulation transformer to isolate the PV side and AC side.
- Never touch either the positive or negative pole of PV connecting device. Strictly prohibit touching both of them at the same time.
- The unit contains capacitors that remain charged to a potentially dangerous voltage after the MAINS, battery and PV supply has been disconnected.
- Hazardous voltage will present for up to 5 minutes after disconnection from power supply.

- CAUTION-RISK of electric shock from energy stored in capacitor, never operate on the inverter couplers, the MAINS cables, Battery cables, PV cables or the PV generator when power is applied. After switching off the PV , battery and Mains, always wait for 5 minutes to let the intermediate circuit capacitors discharge before unplug DC ,battery plug and MAINS couplers.
- When accessing the internal circuit of inverter, it is very important to wait 5 minutes before operating the power circuit or demounting the electrolyte capacitors inside the device. Do not open the device beforehand since the capacitors require time sufficiently discharge!
- Measure the voltage between terminals DC+ and DC- with a multi-meter (impedance at least 1Mohm) to ensure that the device is discharged before beginning work (35VDC) inside the device.

Anti-Islanding Effect

- The islanding effect is a unique phenomenon that occurs when a grid-connected PV system continues to supply power to the local grid despite voltage loss in the power system. This can be dangerous for maintenance personnel and the public. The MCIV series inverter provides Active Frequency Drift (AFD) to prevent the island- ing effect.

PE Connection and Leakage Current

- The end-use application shall monitor the protective conductor by residual current operated protective device (RCD) with rated fault current $I_{fn} \leq 30\text{mA}$ which automatically disconnects the device in case of a fault. The device is intended to connect to a PV generator with a capacitance limit of about 700nf.



Warning!

Warning!
High leakage current!
Earth connection essential before connecting supply.

- Incorrect grounding can cause physical injury, death or equipment malfunction and increase electromagnetic.
- Make sure that grounding conductor is adequately sized as required by safety regulations.
- Do not connect the ground terminals of the unit in series in case of a multiple installation. This product can cause current with a DC component, Where a residual current operated protective (RCD) or monitoring (RCM) device is used for protection.
- In case of direct or indirect contact, an RCD or RCM of type B is recommended on the supply side of this product.

For United Kingdom

- The installation that connects the equipment to the supply terminals shall comply with the requirements of BS 7671.
- No protection settings can be altered.
- User shall ensure that equipment is so installed, designed and operated to maintain at all times compliance with the requirements of ESQCR22(1)(a).

For Australia and New Zealand

- Electrical installation and maintenance shall be conducted by licensed electrician and shall comply with Australia National Wiring Rules.



Notice

Notice!

The system detects a thermal runaway (Venting of gaseous electrolyte; Burning of the cell, spark formation and ignition of vented gas mixtures; Explosion of the cell), it wirelessly sends a thermal runaway signal to the user's alarm system to inform the user that a thermal runaway has occurred. Users need to configure buzzer alarm products at home. (The alarm light is red, and the alarm buzzer has a sound level greater than 85dB but less than 110dB, with a frequency below 3.5kHz.)

2.3 Handle Heavy Loads Safely

Personal Protective Equipment



Safety Gloves



Safety shoes

- When carrying heavy objects, you should be prepared to bear the weight to avoid being crushed or sprained by heavy objects.

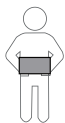

< 18 kg
(< 40 lbs)



18-32 kg
(40-70 lbs)



32-55 kg
(70-121 lbs)

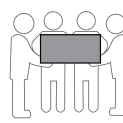

55-68 kg
(121-150 lbs)

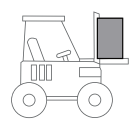

> 68 kg
(> 150 lbs)

- When multiple people carry heavy objects at the same time, it is necessary to consider the height and other conditions, and do a reasonable job of personnel matching and division of labor to ensure a balanced weight distribution.
- When two or more people are carrying heavy loads together, one person should direct the equipment and lift or lower the equipment at the same time to ensure a uniform pace.
- When handling equipment by hand, you should wear protective gloves, labor protection shoes and other safety protective equipment to avoid injury.
- When carrying the equipment by hand, first approach the object, squat down, use the force of straightening your legs, do not use the strength of your back, slowly and steadily lift the object, and it is strictly forbidden to suddenly jerk or twist the torso.
- Do not quickly lift heavy objects to waist height, but place them on a half-waist high workbench or an appropriate place, adjust the position of your palms, and then lift them.
- Carrying heavy objects must be balanced and stable; The speed of movement should be uniform and low; Positioning is required to be smooth and slow, so as to avoid any impact or drop that scratches the surface of the equipment or damages the components and cables of the equipment.

3 Introduction

3.1 Basic Features

Balcony PV products are sold with accessories (two PV module versions) or without accessories (single-microinverter version). The products sold with accessories can be divided into two versions: crystalline silicon module version and flexible module version.

A product sold with accessories offers a complete balcony PV generation system that consists of PV modules, mounting brackets, a microinverter, and wiring cables. A product sold without accessories offers only a single microinverter. According to the specifications of the microinverter, you can purchase suitable PV modules with corresponding brackets for a DIY balcony PV system.

Just several simple steps are required to securely attached the product on the balcony. After firmly attaching to the balcony and plugging the adapter cable into an ordinary receptacle, you can enjoy the green power provided by the sun with ease. The balcony PV product has a module-level MPPT function with MPPT efficiency can be up to 99% or above. Our independent conversion efficiency optimization allows more solar power to be converted into available electricity. The balcony PV product with Wi-Fi communication is provided with a smart networking and monitoring system, which supports remote parameter setting, firmware upgrade, and modular monitoring for its safe, smart, and high-efficiency operation.

Easy Installation

You just need to refer to the installation instructions to complete its installation.

Multiple Product Versions

You can purchase a one-stop package product or a single microinverter for DIY according to your requirements. In addition, both crystalline silicon module version and flexible module version are available for package products. Each package product is provided with an AC adapter and an AC adapter cable, both of which enable the balcony PV system to be plug-and-play.

Remote control

The product can be monitored online via Wi-Fi. An app can be used to view and control all its modules. In addition, you can control the start-up and shutdown of the balcony PV product and view the related information such as generated power statistics.

Descriptions of Model Numbers

Product model	Product name	Remarks
MH-BPM-S0.8P0.8T1	Crystalline silicon module package	
MH-BPM-S0.8P0.8T2	Flexible module package	
MH-MCIV0.8-SN	800W microinverter	

3.2 Typical Application Scenarios

The end user can build a balcony PV power generation system with a package product or a single microinverter (DIY).

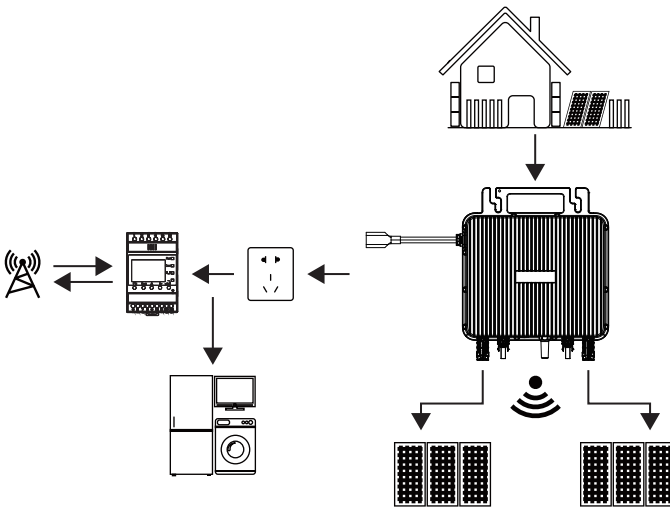







3.3 Packing Lists

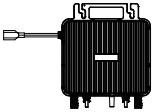

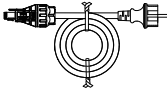

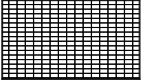
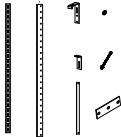
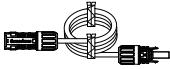
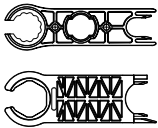
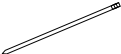

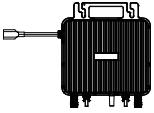

Check one of the following packing lists to ensure the delivered product has all the parts.

The complete system shall be delivered on-site to the customer, including:

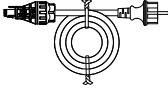

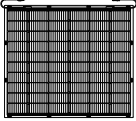

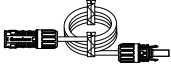
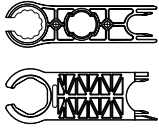
Packing List of Crystalline Silicon Module Version

				
1 microinverter	1 M4×8 ground screw	1*5m-long AC cable (cordial area 1mm ²)	1 user manual	2 crystalline silicon PV modules
				
2 sets of PV brackets (refer to 4.3.1 for details)	2*1m PV extension cables (4mm ²)	1 PV/AC unlocking tool	Nylon tie	1 quick guide

Packing List of Flexible Module Version

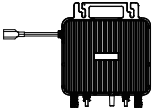
				
<p>1 microinverter</p>	<p>1 M4×8 ground screw</p>	<p>1*5m-long AC cable (cordial area 1mm²)</p>	<p>1 user manual</p>	<p>4 flexible PV modules</p>
				
<p>1 hook assembly</p>	<p>2*1m PV extension cables (4mm²)</p>	<p>1 PV/AC unlocking tool</p>	<p>Metal tie</p>	<p>1 quick guide</p>

Packing List of Single-inverter Packaging

				
<p>1 microinverter</p>	<p>1 M4×8 ground screw</p>	<p>1 user manual</p>	<p>1 quick guide</p>	

3.4 Product Appearance and Dimensions

3.4.1 Crystalline silicon module package

2 PV modules & 2 sets of brackets per package:

Packaging dimensions: 1780*1155*37mm

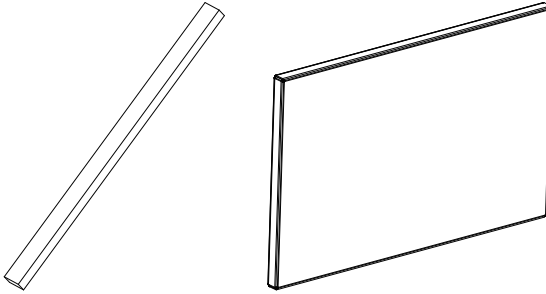

1 inverter suitcase: 405*370*145mm Packaging dimensions:

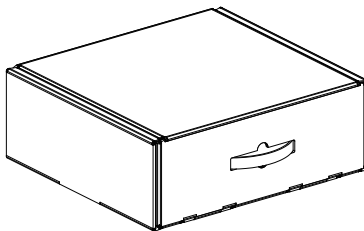

3.4.2 Flexible module package

1 PV module set per package: 1600*890*105mm



1 microinverter suitcase: Packaging dimensions: 405*370*145mm

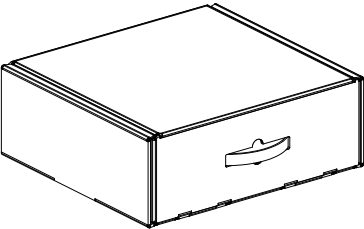

3.4.3 Single-inverter Version

1 microinverter suitcase: Packaging dimensions: 400*368*104mm

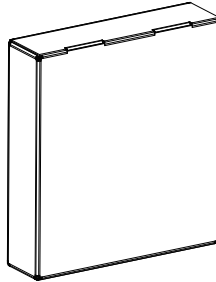

3.5 Interfaces

The microinverter has both AC & DC interfaces. There are two pairs of DC interfaces (PV connectors) on the PV side. On the AC side, there is a AC interface (AC harness and connector) that needs to be connected to the AC cable with a European-standard socket.

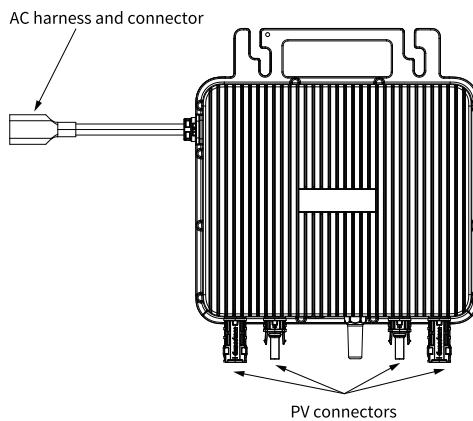

4 Installation



Notice

Be careful during unpacking; otherwise, its components may be damaged.

4.1 Check whether the product has any physical damage.

Visually check that the packages of the product are intact during shipping. If it has any obvious damage, such as a crack, contact your local retailer immediately.

4.2 Product Installation

Installation notes

Note that both the AC adapter connectors should match with each other. Ensure that their model numbers are the same. If both the adapter connectors are not compatible with each other, serious consequences may be incurred. Equipment damage incurred due to this reason is not covered by the warranty.

Note that the output voltage range of each PV module should be consistent with the corresponding input voltage range of the microinverter.

It is recommended that the incoming and outgoing cables of the balcony PV product should be kept at a certain spacing to avoid their interwinding.

The inputs of the balcony PV product are connected to the PV modules and its output is connected to an ordinary household socket via the AC adapter terminal and cable. A cable connection error may damage this product.

The microinverter in balcony PV product is specially designed for outdoor installation (IP 67). Ensure that the installation site meets the following conditions:

- There is no direct sunlight exposure.
- No highly inflammable materials are stored.
- There is no potential explosion risk.
- It is not close to any TV antenna or antenna cable.
- The elevation is not higher than 2000m or so.
- Good ventilation is provided.
- The ambient temperatures range from -40°C to +45°C.
- PV modules do not need to be grounded.
- The cross-sectional area of the external grounding wire should be no less than 2.5mm² if mechanical protection is provided. Without mechanical protection, it should be no less than 4mm². Breaker selection must comply with local regulations.
- The connection between the PV side and the photovoltaic module should be equipped with a PV-specific circuit breaker that complies with IEC60947-3 or IEC60898 standards. The recommended specifications for the circuit breaker are 250Vdc, 25A. Breaker selection must comply with local regulations.
- The AC side at the connection point with the grid should be equipped with an AC circuit breaker that complies with IEC60947-2 or IEC60898 standards. The recommended specification for the circuit breaker is 250Vac, 16A. Breaker selection must comply with local regulations.

4.3 Installation Procedure



4.3.1 Installation of Crystalline Silicon Module Package

Its installation must comply with the local laws and regulations. Before installation, check the dimensions of the balcony. If the width of the balcony is less than 3.5m, the product should not be installed.

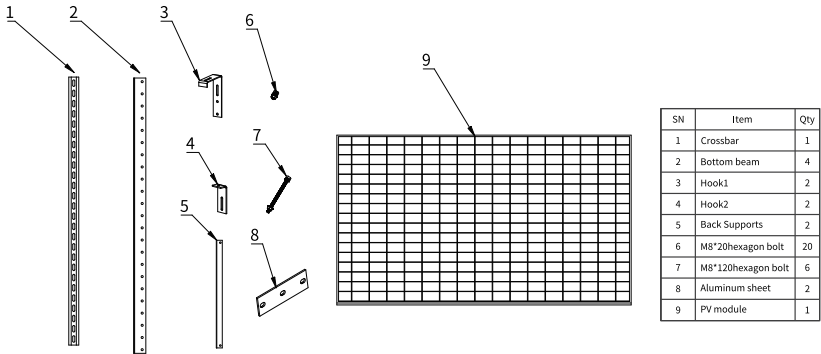
I. PV Module and Mounting Brackets



II. Installation Tools

		
<p>2 open-end wrenches</p>	<p>Torque Socket Wrench</p>	<p>1 pair of safety gloves</p>

III. Installation Procedure

The post-installation overall effect drawing is as follows:

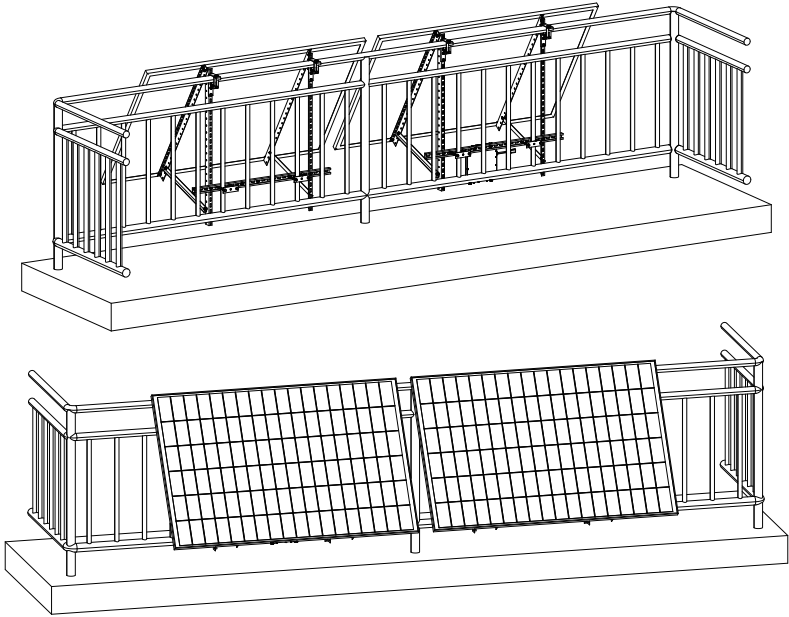

1. Installation of Bottom Beams and Back Supports

① Put the PV panel in the horizontal position, upside down. Install and attach the two bottom beams on the PV module with four M8*20 hexagon bolts. The torque of beam attaching is 18~30N·m.

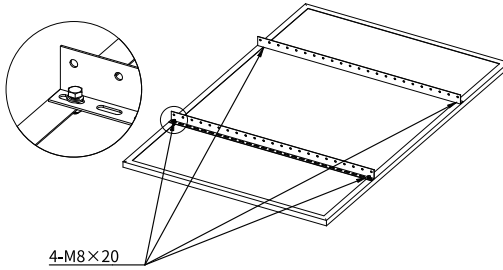

② Install the two back supports as well as the two bottom beams. Adjust the angles between the bottom beams and back supports (30° to 42°). Fix the triangular brackets with six M8*20 bolts. The torque of beam attaching is 18~30N·m.

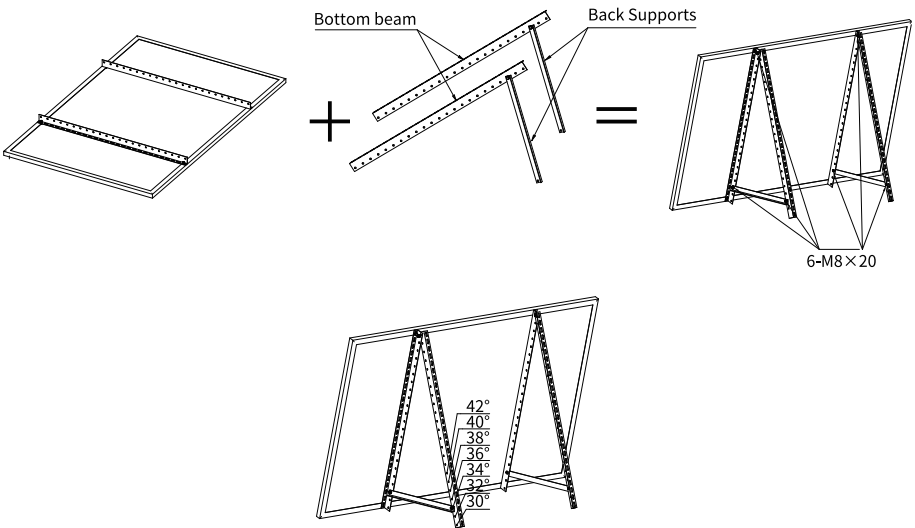

3. Crossbar Installation

Place the crossbar at an appropriate height and attach it to the triangular brackets with M8×20 hexagon bolts. The torque of crossbar attaching is 18~30N·m.

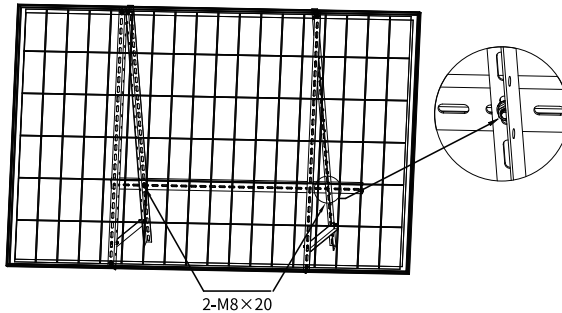

4. Installation of Microinverter and Hooks

(1) Move the hooks to appropriate positions, depending on the width of the handrail. Put the M8×20 hexagon bolts into place and tighten them to a certain degree (adjustable hook range: 35-70mm). The torque of screw attaching is 18~30N·m.

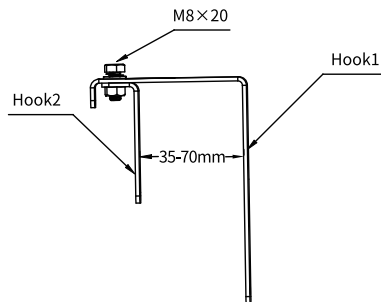

(2) Use two M8×20 hexagon bolts to attach the hooks to the bottom beam. The torque of hook attaching is 18~30N·m. The second hook's fixing method is as follows:

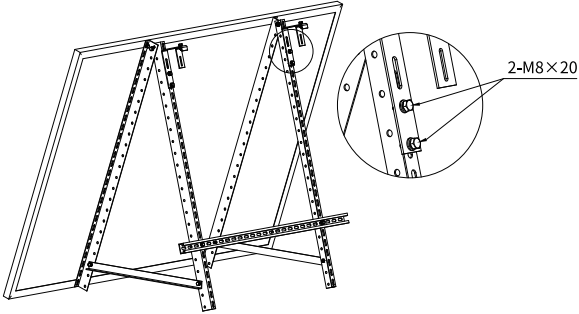

(3) Use two M8×20 hexagon bolts to attach the microinverter. The torque of microinverter attaching is 18~30N·m.

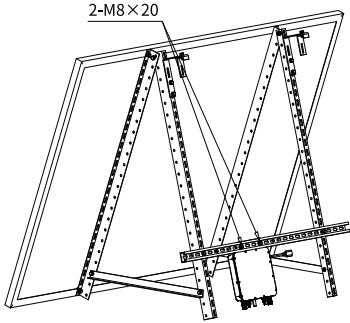

(4) Tie the positive and negative PV harnesses of the module to the crossbar and connect them to a pair of PV interfaces on the microinverter.

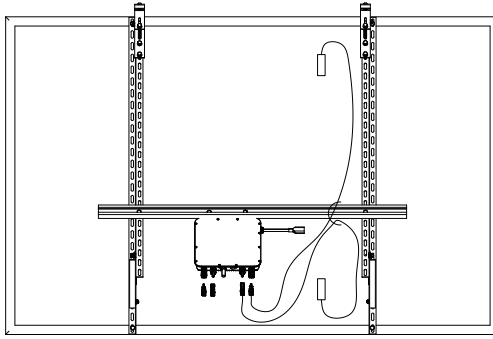

Connect the male connector of the PV module to one of the female connectors on the microinverter, and connect the female connector of the PV module to the corresponding male connector on the microinverter. The PV connectors of each module need to be connected to a pair of PV interfaces on the microinverter.

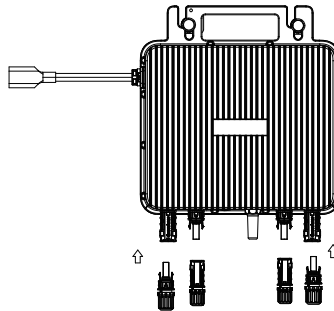

(5) After the hooks are installed, put a PV panel into the balcony. After adjustment, fix them with two M8×20 hexagon bolts and tighten the M8×120 hexagon bolts. The torque of screw attaching is 18-30N·m.

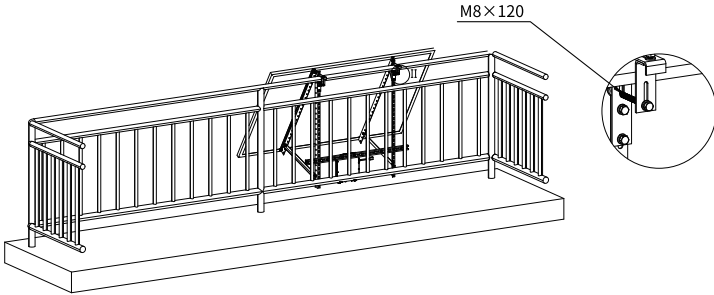

(6) Lower end of bracket is fixed.

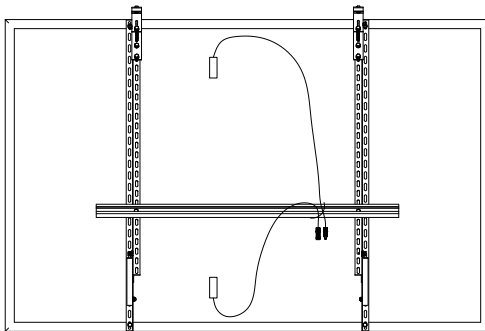
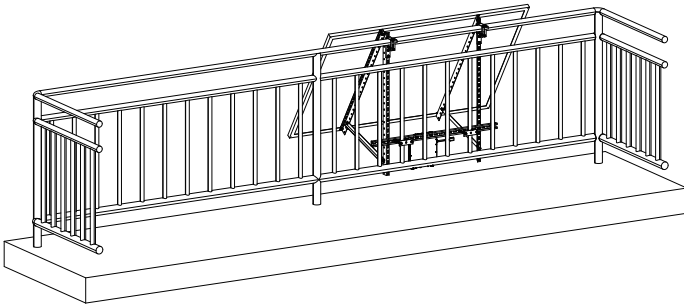

(7) Prepare the second PV module and tie its PV harnesses to the crossbar. Install it on the balcony by repeating the installation procedure of the first PV module.

(8) Complete the wiring of the second PV module.

A double-ended PV panel extension cable is used to connect the two PV cables.

It is recommended that the PV harnesses should be tied at an appropriate position.

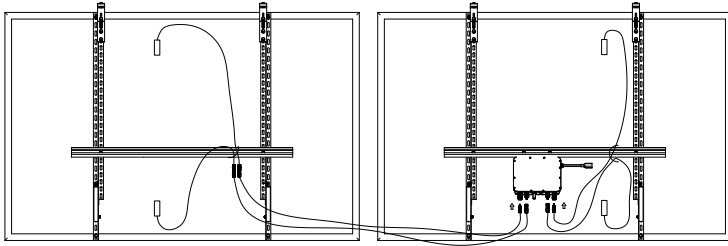

The completion of balcony solar crystalline silicon PV module package is as follows.

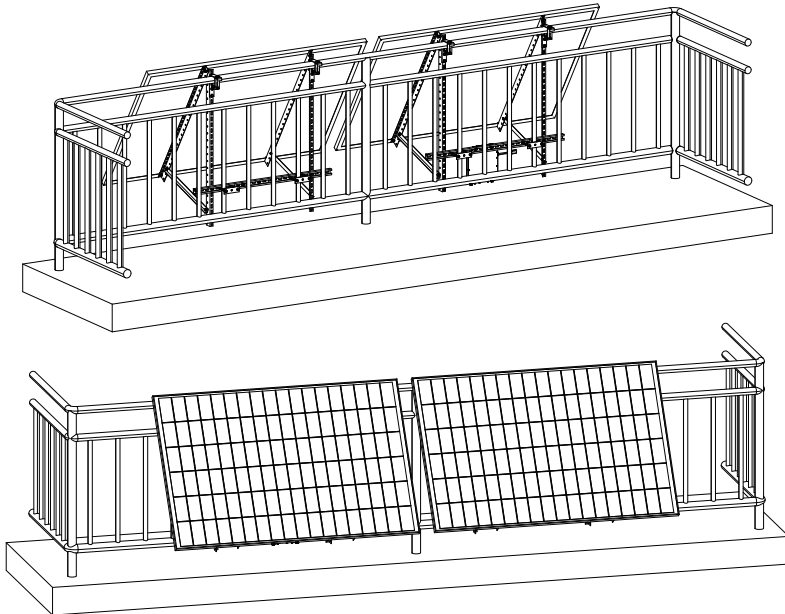

5. AC Harness Connection

Connect the 5m-long harness with a European-standard plug at one end without a plug to the AC connector on the microinverter and connect the other end with a European-standard plug to the socket.

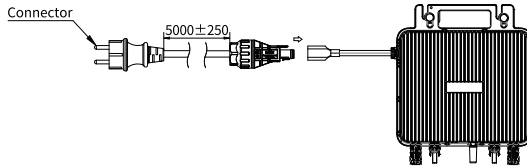

4.3.2 Installation of Flexible Module Package

Its installation must comply with the local laws and regulations. Before installation, check the dimensions of the balcony. If the width of the balcony is less than 3.5m, the product should not be installed here.

I. Installation Accessories of Flexible Module Version

SN	Item	Qty
1	Hook1	2
2	Hook2	2
3	M8*20hexagon bolt	6
4	M8*120hexagon bolt	2
5	Foam	4
6	Metal tie	48
7	PV module	4

II. Installation Tools



1 open-end wrench



1 pair of safety gloves

III. Installation Procedure

1. Securely attach the flexible module to the balcony railing with metal ties.

Fix it with 12 metal ties.

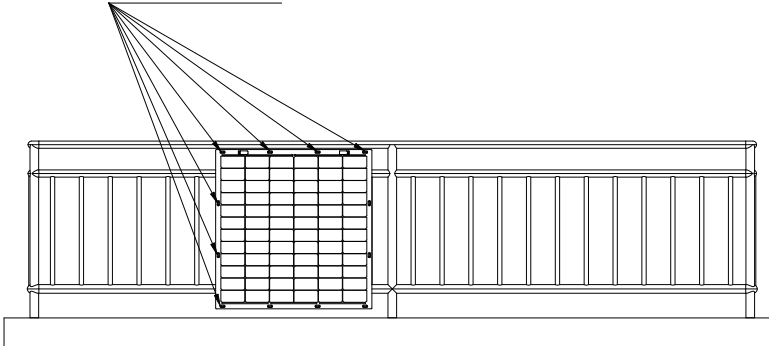

After installing the first PV module, install the other three PV modules using the same method. Note that the third panel shall be 400mm away from the second panel.

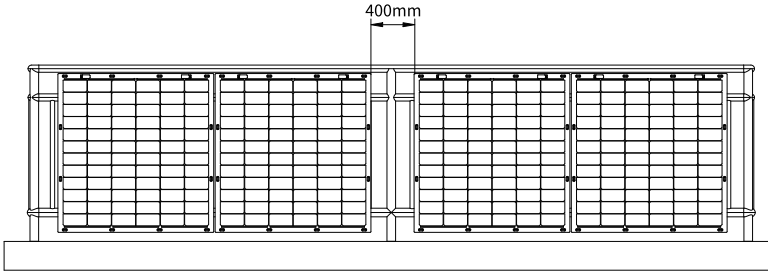

Remarks: The above is the recommended flexible module installation procedure; in order to fix a PV module, at least two ties should be made on each side of the module (top, bottom, left side, and right side).

2. Microinverter Installation

(1) Move the hooks to appropriate positions, depending on the width of the handrail. Use M8×20 hexagon bolts to fix them (adjustable hook range: 35-70mm). The torque of screw attaching is 18~30N·m.

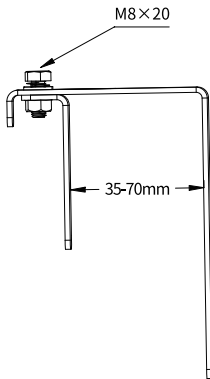

(2) Use two M8×20 hexagon bolts to attach the hooks and microinverter. The torque of screw attaching is 18~30N·m.

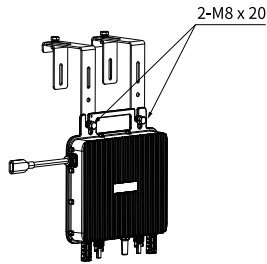

(3) After the hooks are installed, hang the microinverter on the balcony. After position adjustment, securely attach the microinverter with two M8×120 hexagon bolts. The torque of bolt attaching is 18~30N·m.

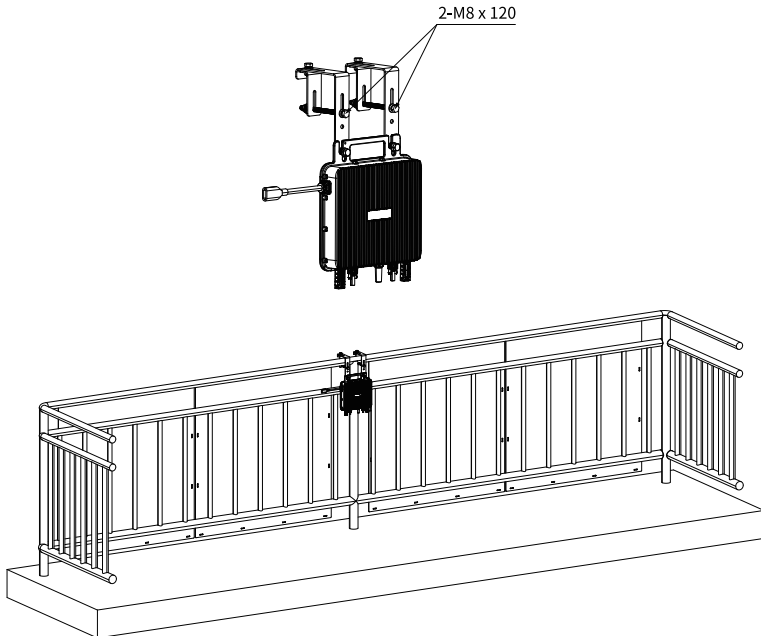

3. Cable Connections

Two flexible panels are connected in series as one set. In a single set, the PV+ of one flexible panel is connected to the PV- of the other flexible panel.

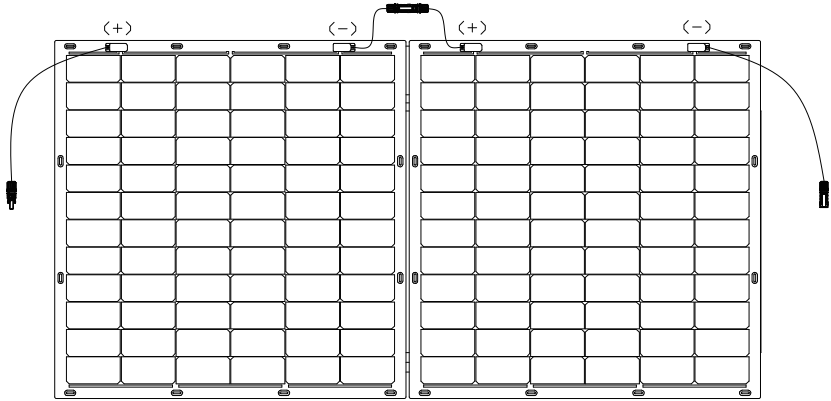

4. Connections to Microinverter

(1) Hang the microinverter between the two sets of flexible PV panels on the balcony. Connect the remote-end harnesses to the PV extension cables provided as accessories.

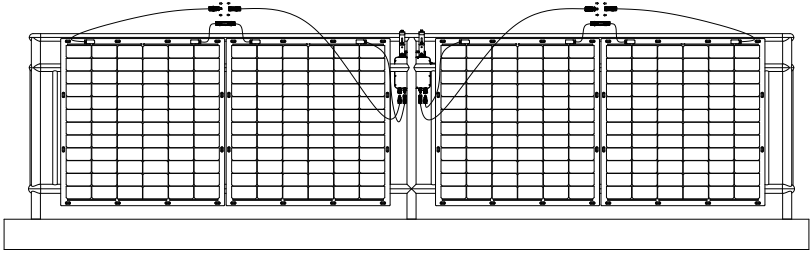

(2) Connect the two flexible panels on each side to a pair of PV interfaces on the microinverter.

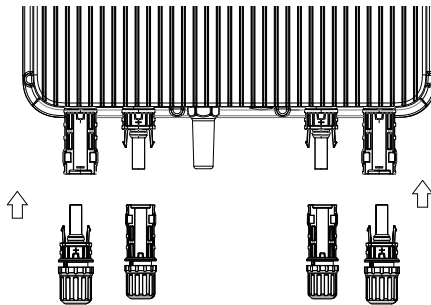

The completion of balcony solar flexible module package is as follows.

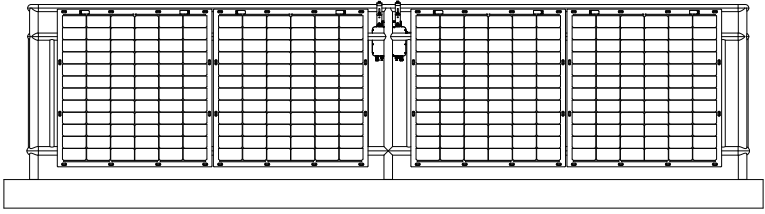

5. AC Harness Connection

Take the 5m-long harness with a European-standard plug at one end out of the package. Connect its end without a plug to the AC connector on the microinverter and connect the other end with a European-standard plug to the socket.

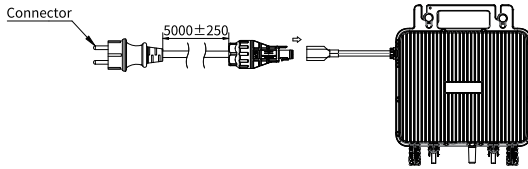

4.3.3 Installation Instructions of Single-inverter Version

1. Connect the two PV connector interface pairs of the microinverter on the PV side to the corresponding interfaces of the PV panels from a third party.

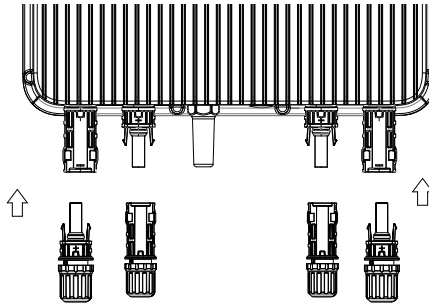

2. Connect to the AC-side adapter interface the AC cable with a socket that is provided as an accessory.

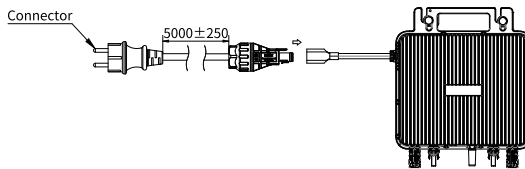

5 Product Setting Procedure

5.1 Monitoring Platform Download

Scan the following QR code with your phone or make a search for SOLARMAN Smart in the Android or iPhone app store, and download SOLARMAN Smart. In addition, you can also visit the web version (<https://home.solarmanpv.com>) to view the data.



SOLARMAN Smart

5.2 Account Creation

Launch the SOLARMAN Smart app and click **"Register a new account"** to create an account.

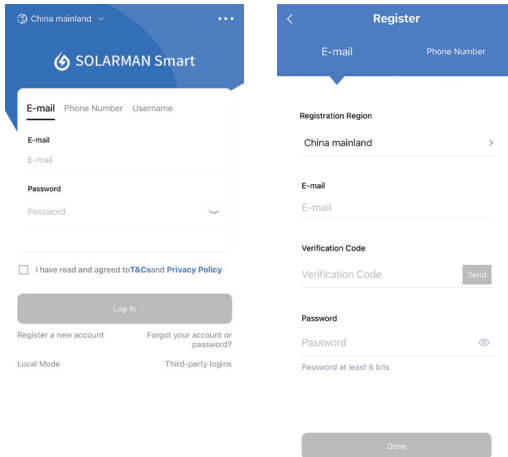

5.3 Plant Creation

Click "Add Now" and fill in the basic information.

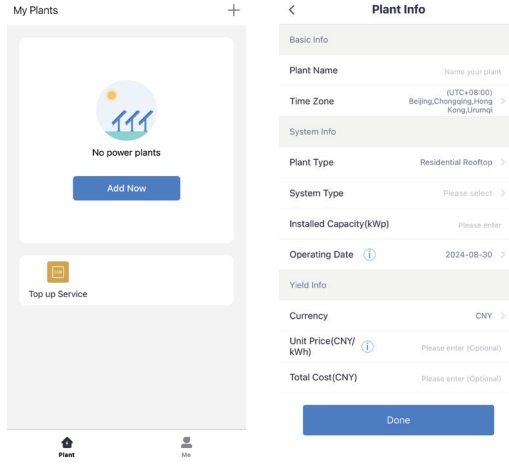

5.4 Logger Adding

Click "Go To Add" and then manually input the serial number or scan the QR code.

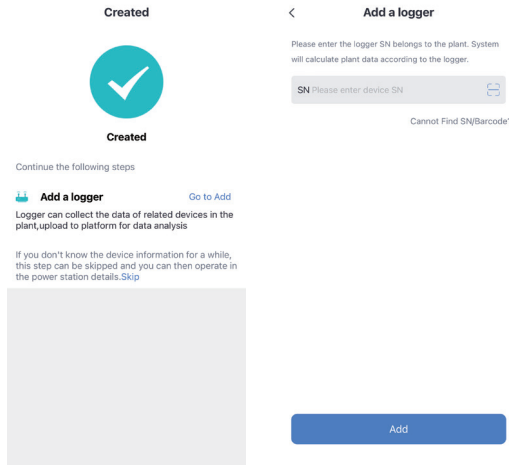

5.5 Network Configuration

Click **"Go to Configure"** to configure the network. Because 5G is not supported, please select 2.4G. (Keep both Wi-Fi and Bluetooth functions enabled on the phone)

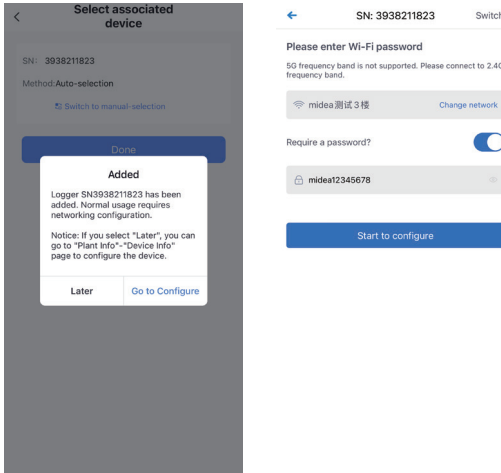

Wait a few minutes, click "Done", and view the plant data.

5.6 View Power Generation Status of Balcony PV System

Launch the monitoring app on the phone and complete the configuration according to the operation instructions given on the app. After the configuration is completed, you can view the real-time power generation status of the balcony PV system as well as the historic generated power statistics.

6 Fault Information

The microinverter can control the color and flashing frequency of the indicator light according to its working status. The specific logics are as follows:

Start-up: the green light flashes quickly (on for 0.1s and off for 0.1s).

Running: the green light flashes once slowly (on for 0.2s and off for 2.8s) every three seconds.

Fault: the red light indicates that a fault has occurred.

The detailed fault information is given in the following table.

NO.	Flashing red light	Fault cause	Countermeasure
1	The red light is normally on.	DC-end undervoltage	Check whether the PV panel is covered or there is any loose PV panel connector.
2	The red light flashes once for short every three seconds.	DC-end overvoltage	Check whether the PV panel wiring is correct. Only a crystalline silicon module can be connected in a circuit or two flexible panels are series connected. If one or more third-party PV modules are used, their specifications shall comply with the requirements given in the manual.
3	The red light flashes twice for short every three seconds.	The inverter is remotely shut down	The product may be abnormal. Contact your local retailer or our after-sales personnel.
4	The red light flashes three times for short every three seconds.	Grid voltage fault	Use a multimeter to measure whether the grid voltage is within the normal working range and check whether the AC cable is properly connected.
5	The red light flashes four times for short every three seconds.	Grid frequency fault	Check whether the country and region set in the app are correct. After they are modified, pull off the PV connectors and restart the inverter.
6	The red light flashes five times for short every three seconds.	Array insulation impedance detection fault	Check whether the PV module is damaged, whether the surface of the PV module is broken, and whether there is any water ingress within the module.
7	The red light flashes once for long and then once for short every three seconds.	There is an overvoltage fault in the inverter.	Check whether the PV ports are properly connected and whether the AC port is properly connected.

8	The red light flashes once for long and then twice for short every three seconds.	There is overcurrent protection within the inverter.	Restart the inverter and check whether the grid voltage is abnormal and whether there is any other household load fault.
9	The red light flashes once for long and then three times for short every three seconds.	The inverter shuts down due to temperature protection.	Check whether there is good ventilation around the inverter and whether the inverter is away from any heat source. If the inverter still fails to work normally, contact your local retailer or our after-sales personnel.

Remarks: (1) The red light flashing for short means that it is on for 0.2s.

The red light flashing for long means that it is on for 1s.

(2) Reset: the red light is on for 0.1s and off for 0.1s and the green light flashes quickly.

7 Packaging, Shipping, and Storage

- The product is packaged in a cardboard box. The internal PE packaging bag is used for moisture protection.
- Between the cardboard box and the packaging bag are EPE foam cushions that are meant to prevent the product from being damaged during handling.
- Its shipping must comply with the relevant laws and regulations.
- Due to heaviness, the product must be mechanically handled.
- Shipping temperatures: -40°C to 40°C.
- Neither the product nor its outer package must be stained. Therefore, the product cannot be exposed to the open air during shipping.
- Storage temperatures: -40°C to 70°C.
- Storage humidity: 5% to 95%RH (without condensation).
- The storage room shall be well-ventilated, clean, and dry. Dustproof and moistureproof measures shall be taken.
- The sunlight into the storage room cannot shine on the inverter.

8 Parameter

MODEL	MH-MCIV0.8-SN
PV Input.	
Max. input voltage [V]	60
Operating voltage range [V]	16-60
MPPT voltage range for rated power [V]	32-45
Startup voltage [V]	22
Max. input current [A]	14/14
Max. short circuit current [A]	25
Number of MPPTs	2
Max. number of PV strings per MPPT	1
Max. inverter backfeed current to the array[A]	0
AC Grid Side (On-grid)	
Rated/Max. Output Power [W]	800
Rated/Max. Output Apparent Power [VA]	800
Rated grid voltage [V]	~230V, L/N/PE
Grid voltage range [V]	187~253
Rated grid frequency [Hz]	50/60
Grid frequency range [Hz]	50/60±1.5
Max. output current [A]	3.5
Rated output current [A]	3.5
AC fault short circuit current	20A
Output overcurrent protection current	10A
Power factor	≥0.99 (Adjustable from 0.8 leading to 0.8 lagging)

I.THD [%]	<3@Rated power
MPPT efficiency [%]	99.8
Max. efficiency [%]	95.5

Protection

LVRT	YES
HVRT	YES
Anti-islanding protection	YES
AC overvoltage / undervoltage protection	YES
AC short circuit protection	YES
AC overcurrent protection	YES
AC surge protection	YES
PV insulation resistance detection	YES
PV reverse polarity protection	YES
PV input overvoltage protection	YES

System data

Ingress protection	IP67
Pollution degree	PD3(outside) PD2(inside)
Protection class	Class I
Overvoltage category	III (AC), II (PV)
Operating temperature range [°C]	-40 to +65 (>45°C derating)
Max. operation altitude [m]	≤2000
Relative humidity	0%~100%
Cooling method	Natural Convection

User interface	LED
Communication with portal	WiFi
RF operating frequency band	2.412GHz-2.472GHz
RF Max. output power	802.11b: 17.69dBm (eirp)
	802.11g: 18.78dBm (eirp)
	802.11n: 18.50dBm (eirp)
Dimension (without connector) (W*H*D) [mm]	246±0.5 * 235.5±0.5 * 40.5±0.5
Weight [kg]	3.6±0.2
Topology	Isolated
PV connector	MC4
AC connector	Quick Plug
Storage temperature [°C]	-40~+70

HICONICS

HICONICS ECO-ENERGY DRIVE TECHNOLOGY CO., LTD.

No.3 Boxing 2nd Road, Economic and Technological Development
Zone 100176 Beijing P.R.China
Tel: +86 10 5918 0033
Email: hiconics_service@midea.com
Web: www.hiconics-global.com