

**HICONICS**

A member of Midea group

# HEC2 THREE PHASE RESS USER MANUAL

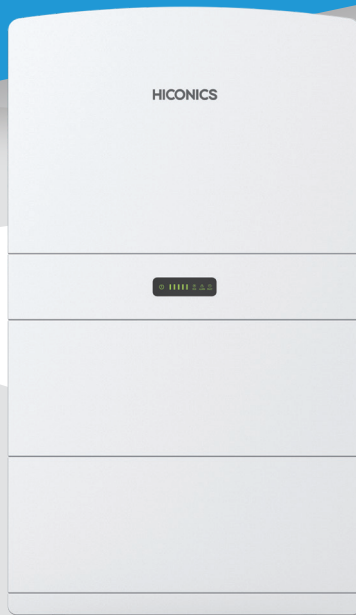

## EXCLUSION OF LIABILITY

All names, trademarks, product names or other designations used in this manual may be legally protected even if not indicated as such (e.g. as a trademark). **HICONICS ECO-ENERGY DRIVE TECHNOLOGY CO., LTD.** assumes no liability or warranty for their free usage. The illustrations and texts have been compiled with great care. However, the possibility of errors cannot be ruled out. The compilation is made without any guarantee.

## GENERAL NOTE ON GENDER EQUALITY

**HICONICS ECO-ENERGY DRIVE TECHNOLOGY CO., LTD.** is aware of the importance of language with regard to the equality of women and men and always makes an effort to reflect this in the documentation. Nevertheless, for the sake of readability we are unable to use non-gender-specific terms throughout and use the masculine form instead.

© 2023 HICONICS ECO-ENERGY DRIVE TECHNOLOGY CO., LTD.

All rights reserved by HICONICS ECO-ENERGY DRIVE TECHNOLOGY, including those of reproduction by photocopy and storage in electronic media. Commercial use or distribution of the texts, displayed models, diagrams and photographs appearing in this product is not permitted. This manual may not be reproduced, stored, transmitted or translated in any form or by means of any medium, in whole or in part, without prior written permission.

# CONTENTS

<b>1 Notes on this Manual .....</b>	<b>01</b>
1.1 Scope of Validity .....	01
1.2 Target Group .....	02
1.3 Symbols Used.....	02
1.4 EU Declarations of Conformity.....	02
1.5 Release Notes.....	03
<b>2 Safety.....</b>	<b>04</b>
2.1 Notes on this Manual Explanation of Symbol.....	04
2.2 Important Safety Instructions.....	06
2.3 Battery Safety Instructions.....	11
2.4 Handle Heavy Loads Safely.....	13
2.5 Network Security .....	14
2.6 Security Update .....	14
2.7 Channel for Handling Security Issues.....	15
2.8 Recycling and Treatment .....	15
<b>3 Introduction.....</b>	<b>17</b>
3.1 Basic Features .....	17
3.2 Work Modes .....	18
3.3 Packing List.....	18
3.4 System Appearance.....	20
3.5 Wiring Port Part.....	20
3.5.1 Inverter .....	20
3.5.2 BMS Control Box.....	23
3.5.3 Battery Module.....	24
3.5.4 Base .....	25
3.6 LED Lights Display Define .....	26
3.6.1 Battery System LED Display Define .....	26
3.6.2 Inverter LED Display Define.....	27
<b>4 Installation.....</b>	<b>28</b>
4.1 Check for Physical Damage.....	28
4.2 Equipment Installation .....	28
4.2.1 Requirement.....	29
4.2.2 Required for Installation.....	30
4.3 Installation Process .....	31
4.3.1 Battery Pack Installation .....	31
<b>5 Electrical Connection.....</b>	<b>36</b>
5.1 Battery System Cable Connection .....	36
5.2 PV Connection.....	36

- 5.2.1 Connection Steps ..... 37
- 5.3 AC Grid Connection ..... 38
- 5.4 BACK UP ..... 39
- 5.5 Communication Interface Connection ..... 42
  - 5.5.1 METER/CT Interface ..... 42
  - 5.5.2 DRM Interface (Optional) ..... 43
  - 5.5.3 CAN Interface..... 44
  - 5.5.4 COM2 Interface..... 45
  - 5.5.5 BMS (to BMS Control Box) Interface ..... 45
  - 5.5.6 ETH1 Interface..... 46
- 5.6 External Smart Meter Connection..... 46
- 5.7 Earth Fault Alarm Connection ..... 48
- 5.8 Wiring Diagram..... 48
- 5.9 Expansion of Battery Capacity..... 49
- 5.10 Install the Side Panel ..... 50
  
- 6 System Operation ..... 52**
  - 6.1 Switch On ..... 52
  - 6.2 Switch Off ..... 55
  
- 7 Plant Monitoring ..... 55**
  - 7.1 Create a Plant (End User Version) ..... 57
  - 7.2 Add a Logger ..... 60
  - 7.3 Networking Configuration..... 63
  
- 8 APP View Data ..... 66**
  - 8.1 Real Time Data ..... 66
  - 8.2 Statistics Data..... 67
  - 8.3 Device Info ..... 67
  - 8.4 Alert Data..... 68
  - 8.5 User Manual of Solarman Smart ..... 68
  
- 9 Fault Information..... 69**
  
- 10 Packaging , Transportation , Storage..... 74**
  - Annex 1: Hybrid Inverter Parameter Table..... 75
  - Annex 2: Product Parameter Table ..... 77
  - Annex 3: System Parameter Table ..... 78

# 1 Notes on this Manual

## 1.1 Scope of Validity

This manual is an integral part of HEC2 series hybrid three phase residential storage system, it describes the assembly, installation, commissioning, maintenance and failure of the product. Please read it carefully before operating.

### Inverter

HEC2-T15.0Hr2-Eu	HEC2-T12.0Hr2-Eu	HEC2-T10.0Hr2-Eu	HEC2-T8.0Hr2-Eu
------------------	------------------	------------------	-----------------

Inverter naming rules, for example: HEC2-T15.0Hr2-Eu

"HEC2" means "HICONICS 2nd generation series"

"T" means "three-phase output"

"15" means "rated output power of inverter is 15kW"

"H" means "high-voltage scheme"

"r2" means "all-in-one system"

"Eu" means "version number"

### Battery

HEC2-BHP100r2-EU	HEC2-BHP150r2-EU	HEC2-BHP200r2-EU	HEC2-BHP200r2-A-EU	HEC2-BHP300r2-A-EU	HEC2-BHP400r2-A-EU
------------------	------------------	------------------	--------------------	--------------------	--------------------

Battery naming rules, for example: HEC2-BHP100r2-EU

"HEC2" means "HICONICS 2nd generation series"

"B" means "battery system"

"H" means "high-voltage scheme"

"P100" means "capacity of battery is 10kWh"

"r2" means "all-in-one system"

"A" means "battery system connects in parallel"

"EU" uses for "version number"

### System Configuration

HEC2-ESS-T 15/40r2-Eu	HEC2-ESS-T 15/30r2-Eu	HEC2-ESS-T 15/20r2A-Eu	HEC2-ESS-T 15/20r2-Eu	HEC2-ESS-T 15/15r2-Eu	HEC2-ESS-T 15/10r2-Eu	HEC2-ESS-T 12/40r2-Eu	HEC2-ESS-T 12/30r2-Eu
HEC2-ESS-T 12/20r2A-Eu	HEC2-ESS-T 12/20r2-Eu	HEC2-ESS-T 12/15r2-Eu	HEC2-ESS-T 12/10r2-Eu	HEC2-ESS-T 10/40r2-Eu	HEC2-ESS-T 10/30r2-Eu	HEC2-ESS-T 10/20r2A-Eu	HEC2-ESS-T 10/20r2-Eu
HEC2-ESS-T 10/15r2-Eu	HEC2-ESS-T 10/10r2-Eu	HEC2-ESS-T 8/40r2-Eu	HEC2-ESS-T 8/30r2-Eu	HEC2-ESS-T 8/20r2A-Eu	HEC2-ESS-T 8/20r2-Eu	HEC2-ESS-T 8/15r2-Eu	HEC2-ESS-T 8/10r2-Eu

Naming rules for all-in-one machines, for example: HEC2-ESS-T15/40r2-Eu

"HEC2" means "HICONICS 2nd generation series"

"ESS" means "Energy Storage System"

"T" means "three-phase output"

"15" means "rated output power of inverter is 15kW"

"40" means "capacity of battery is 40kWh"

"r2" means "all-in-one system"

"Eu" means "version number"

It is recommended that this manual should be stored in a location that will be accessible at all times.

## 1.2 Target Group

This manual is for qualified electricians. The tasks described in this manual only can be performed by qualified electricians.

## 1.3 Symbols Used

The following types of safety instructions and general information appear in this document as described below:



**Danger!**

Indicates a hazard with a high level of risk which, if not avoided, will result in death or serious injury.



**Warning!**

Indicates a hazard with a medium level of risk which, if not avoided, could result in death or serious injury.



**Caution**

Indicates a hazard with a low level of risk which, if not avoided, could result in minor or moderate injury.



**Notice**

Indicates actions of which, if not avoided, could result in material damage.

---

## 1.4 EU Declarations of Conformity

**HICONICS ECO-ENERGY DRIVE TECHNOLOGY CO., LTD.** hereby declares that the inverter described in this document complies with the basic requirements and other relevant conditions of the directives listed below.

Directive 2014/30/EU

(on the approximation of the laws of the Member States relating to electromagnetic compatibility(EMC))

Directive 2014/35/EU

(on the harmonization of the laws of the Member States relating to the making available on the market of electrical equipment designed for use within certain voltage limits-in short: Low Voltage Directive)

Directive 2011/65/EU (RoHS)

(on the restriction of the use of certain hazardous substances in electrical and electronic equipment You will find a detailed EU Declaration of Conformity in the download area at: [www.hiconics-global.com](http://www.hiconics-global.com))

## 1.5 Release Notes

The version log accumulates the description of each document update, with the latest version covering all previous document versions.

V1.0 2024-08-22









First Release

## 2 Safety

### 2.1 Notes on this Manual Explanation of Symbol

This section gives an explanation of all the symbols shown on the inverter and on the type label.

#### Symbols on the Type Label

Symbol	Explanation
	CE mark. The inverter complies with the requirements of the applicable CE
	Australian certification mark.
	TUV SOUTH mark
	TUV mark
	Beware of hot surface. The inverter will become hot during operation. Avoid touch it directly during operation. Danger of high temperature.
	Danger to life due to high voltages in the inverter!
	Danger Risk of electric shock!
	Observe enclosed documentation





The system can't be disposed together with the household waste. Disposal information can be found in the enclosed documentation.



Do not dispose of the battery system together with the household waste but in accordance with the disposal regulations for electronic waste applicable at the installation site.



Warning:  
No fireworks!



Warning:  
Explosive materials!



Recycling.



Do not operate this equipment until it is isolated from battery, grid and on-site PV generation suppliers.



Danger to life due to high voltage.  
There is residual voltage existing in the inverter after powering off. Which needs 5 min to discharge.  
Wait 5 min before you open the upper lid or the DC lid.

## 2.2 Important Safety Instructions

---



### Danger!

Danger to life due to high voltages in the inverter! All work must be carried out by qualified electrician. The appliance is not to be used by children or persons with reduced physical sensory or mental capabilities, or lack of experience and knowledge, unless they have been given supervision or instruction.

---



### Warning!

Danger of burn injuries due to hot enclosure parts! During operation, the upper of the enclosure and the enclosure body may become hot. Only touch the lower enclosure lid during operation.

---



### Caution

Possible damage to health as result of the radiation! Do not stay closer than 20cm to inverter for any length of time.

---



### Notice

Grounding the PV generator.  
Comply with the local requirements for grounding the PV modules and the PV generator. It is recommends connecting the generator frame and other electrically conductive surfaces in a manner which ensures continuous conduction and ground these in order to have optimal protection of system and persons.

---



### Warning!

Do not operate the inverter when the device is running.

---

**Warning!**

Ensure input DC voltage  $\leq$  Max. DC voltage. Over voltage may cause permanent damage to inverter or other losses, which will not be included in warranty!

---

**Warning!**

Risk of electric shock!

---

**Warning!**

Authorized service personnel must disconnect both AC and DC power from inverter before attempting any maintenance or cleaning or working on any circuits connected to inverter.

---

**Notice**

Prior to the application, please read this section carefully to ensure correct and safe application. Please keep the user manual properly.

---

**Danger!**

The accessories which are shipped with the inverter are only recommended, otherwise may result in a risk of fire, electric shock, or injury to person.

---

**Warning!**

Make sure that existing wiring is in good condition and that wire is not undersized.

---

**Warning!**

PV modules shall have an IEC 61730 class A rating.

---

**Warning!**

Authorized service personnel must use insulated tools when installing or working with this equipment.

---



**Danger!**

Do not disassemble any parts of inverter which are not mentioned in installation guide. It contains no user-serviceable parts. See Warranty for instructions on obtaining service. Attempting to service the inverter yourself may result in a risk of electric shock or fire and will void your warranty.

---



**Warning!**

Keep away from flammable, explosive materials to avoid fire disaster.

---



**Warning!**

The installation place should be away from humid or corrosive substance.

---



**Warning!**

The equipment should be installed in areas away from liquids and must not be installed below water pipes, air outlets, or other locations prone to condensation; it must not be installed below air conditioning vents, ventilation outlets, or cable entry windows in machine rooms, which are prone to water leakage, to prevent liquids from entering the equipment and causing malfunctions or short circuits.

---



**Warning!**

When the device is operating, do not block the ventilation openings, cooling system, or cover it with other items to prevent overheating, damage to the device, or fire.

---



**Warning!**

The unit contains capacitors that remain charged to a potentially dangerous voltage after the MAINS, battery and PV supply has been disconnected.

---

**Warning!**

Never touch either the positive or negative pole of PV connecting device. Strictly prohibit touching both of them at the same time.

---

**Warning!**

Hazardous voltage will present for up to 5 minutes after disconnection from power supply

---

**Warning!**

CAUTION-RISK of electric shock from energy stored in capacitor, never operate on the inverter couplers, the MAINS cables, Battery cables, PV cables or the PV generator when power is applied. After switching off the PV, battery and Mains, always wait for 5minutes to let the intermediate circuit capacitors discharge before unplug DC, battery plug and MAINS couplers.

---

**Warning!**

When accessing the internal circuit of inverter, it is very important to wait 5 minutes before operating the power circuit or demounting the electrolyte capacitors inside the device. Do not open the device beforehand since the capacitors require time sufficiently discharge!

---

**Caution**

Measure the voltage between terminals DC+ and DC- with a multi-meter (impedance at least 1Mohm) to ensure that the device is discharged before beginning work (35VDC) inside the device.

---

## Anti-Islanding Effect

- The islanding effect is a unique phenomenon that occurs when a grid-connected PV system continues to supply power to the local grid despite voltage loss in the power system. This can be dangerous for maintenance personnel and the public. The HiEnergy series inverter provides Active Frequency Drift (AFD) to prevent the islanding effect.

## PE Connection and Leakage Current

---



### Notice

The end-use application shall monitor the protective conductor by residual current operated protective device (RCD) with rated fault current  $I_{fn} \leq 240\text{mA}$  which automatically disconnects the device in case of a fault. The device is intended to connect to a PV generator with a capacitance limit of about 700nf.

---



### Warning!

High leakage current!  
Earth connection essential before connecting supply.

---



### Warning!

Incorrect grounding can cause physical injury, death or equipment malfunction and increase electromagnetic.

---



### Caution

Make sure that grounding conductor is adequately sized as required by safety regulations.

---



### Caution

Do not connect the ground terminals of the unit in series in case of a multiple installation. This product can cause current with a DC component, where a residual current operated protective (RCD) or monitoring (RCM) device is used for protection. In case of direct or indirect contact, only an RCD or RCM of type B is allowed on the supply side of this product.

---

---

## For United Kingdom

---

**Caution**

The installation that connects the equipment to the supply terminals shall comply with the requirements of BS 7671.

---

**Caution**

No protection settings can be altered.

---

**Caution**

User shall ensure that equipment is so installed, designed and operated to maintain at all times compliance with the requirements of ESQCR22(1)(a).

---

## For Australia and New Zealand

---

**Caution**

Electrical installation and maintenance shall be conducted by licensed electrician and shall comply with Australia National Wiring Rules.

---

## 2.3 Battery Safety Instructions

---

**Notice**

HiEnergy Series inverter should be worked with high voltage battery, for the specific parameters such as battery type, nominal voltage and nominal capacity etc., please refer to the parameters list.

---

- As accumulator batteries may contain potential electric shock and short-circuit current danger, to avoid accidents that might be thus resulted, the following warnings should be observed during battery replacement:



**Warning!**

Do not wear watches, rings or similar metallic items.

---



**Warning!**

Use insulated tools.

---



**Warning!**

Put on rubber shoes and gloves.

---



**Warning!**

Do not place metallic tools and similar metallic parts on the batteries.

---



**Warning!**

Switch off load connected to the batteries before dismantling battery connection terminals.

---



**Warning!**

Only personal with proper expertise can carry out the maintenance of accumulator batteries.

---



**Notice**

The system detects a thermal runaway (Venting of gaseous electrolyte; Burning of the cell, spark formation and ignition of vented gas mixtures; Explosion of the cell), it wirelessly sends a thermal runaway signal to the user's alarm system to inform the user that a thermal runaway has occurred. Users need to configure buzzer alarm products at home. (The alarm light is red, and the alarm buzzer has a sound level greater than 85dB but less than 110dB, with a frequency below 3.5kHz.)

---



## 2.4 Handle Heavy Loads Safely

- When carrying heavy objects, you should be prepared to bear the weight to avoid being crushed or sprained by heavy objects.

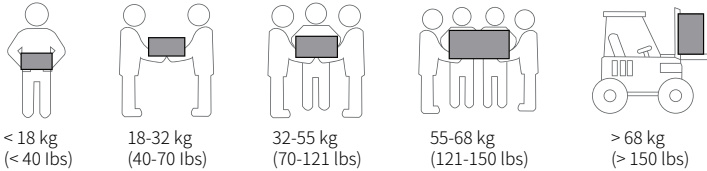

- When multiple people carry heavy objects at the same time, it is necessary to consider the height and other conditions, and do a reasonable job of personnel matching and division of labor to ensure a balanced weight distribution.
- When two or more people are carrying heavy loads together, one person should direct the equipment and lift or lower the equipment at the same time to ensure a uniform pace.
- When handling equipment by hand, you should wear protective gloves, labor protection shoes and other safety protective equipment to avoid injury.
- When carrying the equipment by hand, first approach the object, squat down, use the force of straightening your legs, do not use the strength of your back, slowly and steadily lift the object, and it is strictly forbidden to suddenly jerk or twist the torso.
- Do not quickly lift heavy objects to waist height, but place them on a half-waist high workbench or an appropriate place, adjust the position of your palms, and then lift them.
- Carrying heavy objects must be balanced and stable; The speed of movement should be uniform and low; Positioning is required to be smooth and slow, so as to avoid any impact or drop that scratches the surface of the equipment or damages the components and cables of the equipment.

## 2.5 Network Security

---



### Warning!

Install the gateway. Please do not configure this product in an untrusted network environment.

---



### Caution

Please call the product company's after-sales service number and wait for the after-sales service personnel to come and collect it, and reset this product; If the mobile phone cannot control this product, please reset this product in a secure network environment.

---

## 2.6 Security Update

- Regularly check the battery pack and its connectors for looseness, corrosion, etc., and address any issues promptly.
- Avoid overcharging or over-discharging, as it can affect battery life and may even cause battery damage. This situation should be avoided.
- When installing home energy storage products, follow the instructions in the manual to ensure correct and secure installation.
- Although the product has lightning protection functions, attention should also be paid to avoid lightning strikes and other situations.
- Regular maintenance should be carried out, such as cleaning and checking the battery status, to ensure the normal operation and safety of the product. Specific operations should be performed according to the product manual and the guidance of professionals.

## 2.7 Channel for Handling Security Issues

- After-sales service: Get assistance via phone, email, or online customer service.
- Reporting channel: Report security issues through the after-sales service channel.
- Issue tracking: Track the progress of problem resolution through after-sales service channels.

## 2.8 Recycling and Treatment

- Data Erasure: The product's storage is already encrypted. It is recommended that customers restore the factory settings before removal to clear all user configurations and data.
- Secure disposal: Physically destroy storage media that cannot have data cleared, and dispose of equipment in compliance with environmental regulations.
- Disconnect the product from the power grid or power source and ensure it is completely turned off.

- Confirm if there is still power in the product. If so, place it in a safe location until the power is completely drained.
- If the battery leaks or is damaged, please contact technical support or a battery recycling company for disposal.
- Faulty batteries are prohibited from being reused. Contact the battery recycling company for disposal in a timely manner to avoid environmental pollution.
- Avoid exposing used batteries to high temperatures or direct sunlight, high humidity, or corrosive environments.
- Before disposal, please carefully read the product manual or consult the manufacturer to learn more detailed safety disposal guidelines.
- Please be sure to dispose of it safely in accordance with local laws and regulations. Improper battery disposal may cause environmental pollution or explosion.

## 3 Introduction

### 3.1 Basic Features

HiEnergy Series is high-quality RESS is comprised of inverter and battery, which can convert solar energy to AC electricity.

The HiEnergy Series system offers users the flexibility to optimise self-consumption, store energy in the battery for future use or feed energy into the public grid. Work mode depends on PV energy and user's preference. It can provide power for emergency use during the grid lost by using the energy from battery and inverter generated from PV.

#### System Diagram

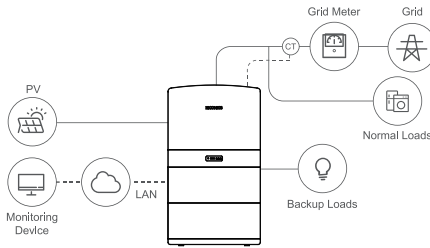

Figure1 DC-coupled Storage System – Scheme

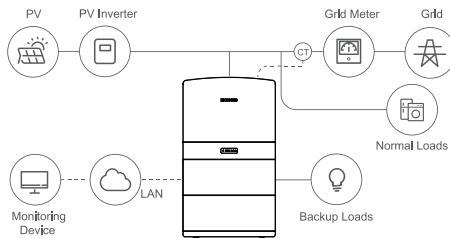

Figure 2 AC-coupled Storage System – Scheme

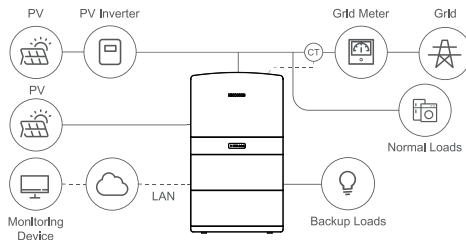

Figure 3 Hybrid-coupled Storage System – Scheme

### 3.2 Work Modes

Three different basic work modes can be set via APP.

- **Self Use:**

In this mode, the electricity generated by PV panel will be used in the following order: the home loads should be fed first, followed by charging the battery and then feeding into the grid. When the electricity from PV is not sufficient, the load will be supported by the battery to enhance self-consumption. If the power supply from the batteries is not sufficient, the grid will support the load demand.

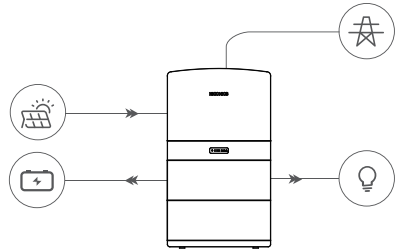

- **Back Up:**

In this mode, the batteries are only used as a backup power supply in the event of a grid failure. As long as the grid is operational, the batteries will not be used to power the loads. The battery will be charged with the power generated by the PV system or from the grid. Product meets 100% unbalanced load.

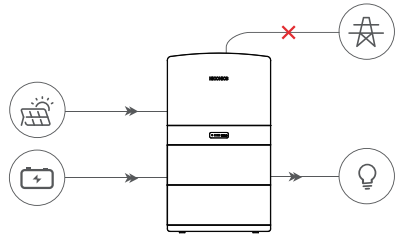

- **Peak Shaving:**



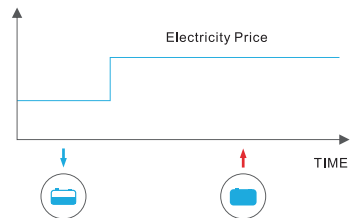





This mode is designed for time-use mode customer. The customer is able to set up the charging/discharging time & power via APP or Website.

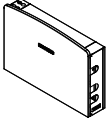
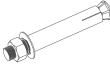
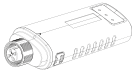
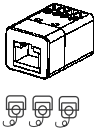

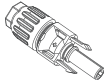

### 3.3 Packing List

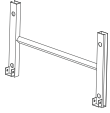
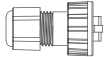
Check the following parts list to ensure it is complete.  
Delivers a total system separately on site to client, this consists of:

## Inverter packing list

				
1x Inverter	4x M8*60	Wi-Fi dongle	3x CT (With RJ45 Adapter)	AC Grid connector (blue)
				
AC load connector (black)	3x PV positive terminal	3x PV negative terminal	1x PE wire between PCS and BMS main box	Connecting wiring harness
				
3x M6*12	1x PCS mounting bracket	5x RJ45 cable end	1x User Manual	Positioning cardboard

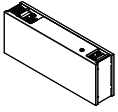
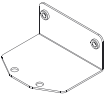
## 2x(Battery packing list)

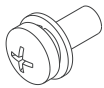
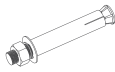
				
Battery pack	2x Mounting bracket	2x Battery bracket	M 5 * 14 (8 PCS)	M 8 * 60 (4 PCS)

## BMS Control box &amp; base

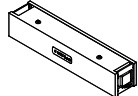
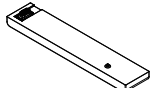
				
1x BMS control box	1x base			

### 3.4 System Appearance

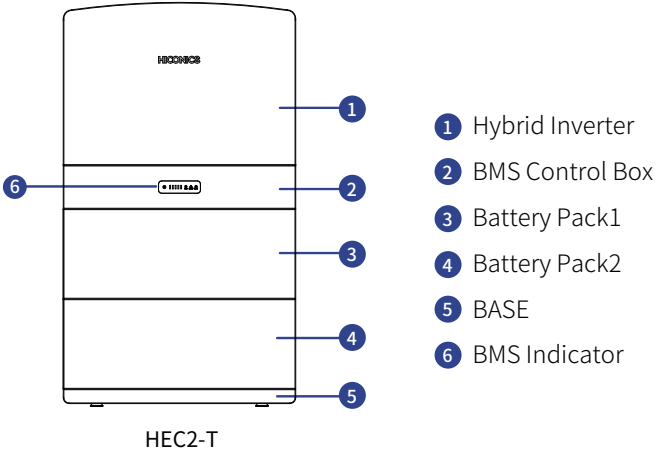

### 3.5 Wiring Port Part

#### 3.5.1 Inverter

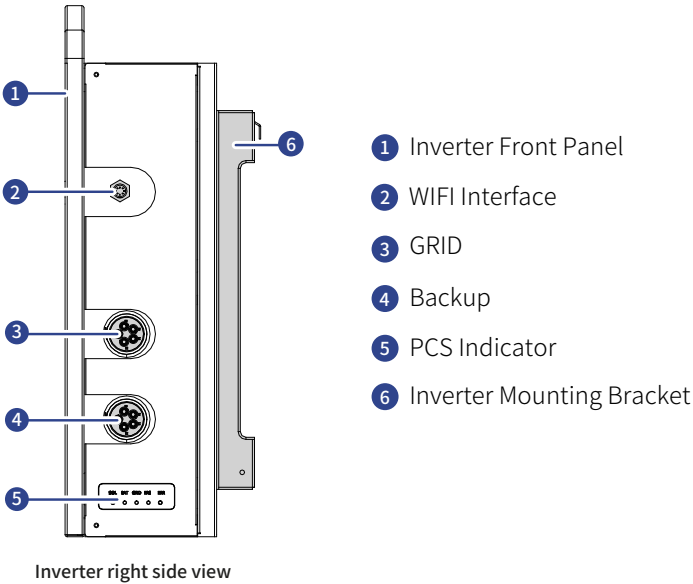



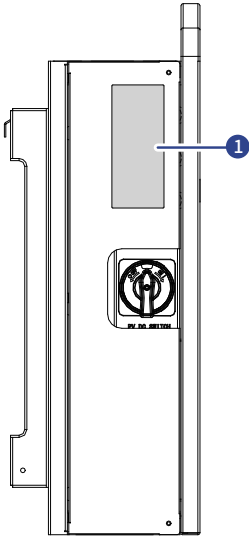

Inverter left view with cover plate

- ① Warning Label Sticking Place

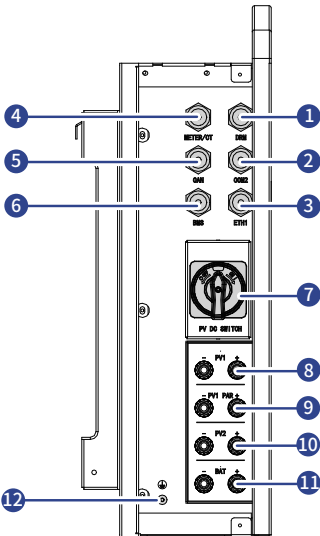

Inverter left view(Opened cover)

- ① DRM Interface
- ② COM2 Interface
- ③ ETH1 Interface
- ④ METER/CT Interface
- ⑤ CAN Interface
- ⑥ BMS Interface
- ⑦ PV DC Switch
- ⑧ PV1
- ⑨ PV1 PAR
- ⑩ PV2
- ⑪ BAT (wiring to BMS control box)
- ⑫ Earthing Pin (protective earthing wire to BMS control box)

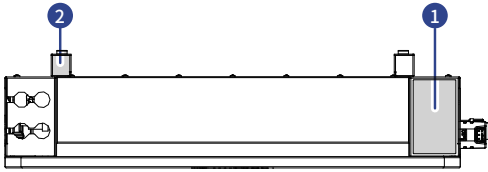

Inverter top view

- 1 Parameter Nameplate Sticking Place
- 2 Mounting Bracket

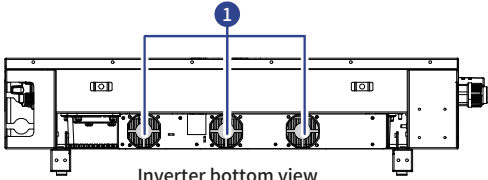

Inverter bottom view

- 1 Cooling Fans

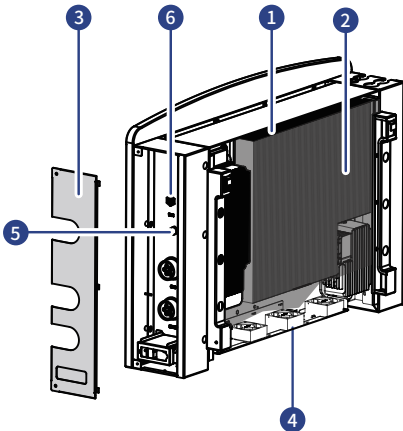

Inverter back explosive view

- 1 Radiator
- 2 Rear Cover
- 3 Right-hand Side Cover
- 4 Cooling Fan
- 5 Explosion-proof Valve
- 6 WIFI Interface

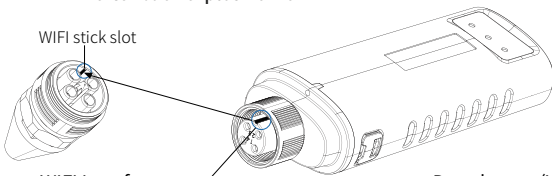

Inverter WIFI Interface

Data-logger (Wi-Fi dongle)

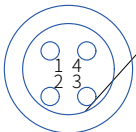

Pin	Network Name
1	VCC
2	GND
3	RS485-A
4	RS485-B

**Note:** The WIFI stick slot has to be aligned to work properly.

### 3.5.2 BMS Control Box



Bottom view

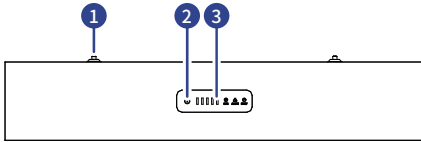

Front view



Top view

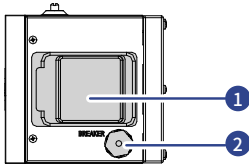

Right view

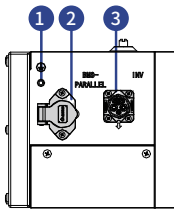

Left view (Opened cover)

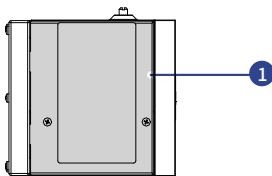

Left view

- 1 Bottom Plug Connector
- 2 Positioner (female)

- 1 Positioner (male)
- 2 Power Button
- 3 BMS Indicator

- 1 Positioner (male)

- 1 Battery Circuit Breaker
- 2 Debug

- 1 Equipotential Bonding Pin (go to Inverter)
- 2 BMS-PARALLEL
- 3 INV

- 1 Protective Cover

### 3.5.3 Battery Module

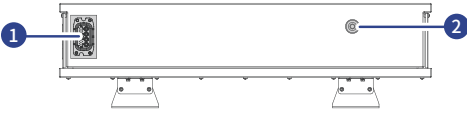

Battery bottom view

- 1 Bottom Plug Connector
- 2 Positioner (female)

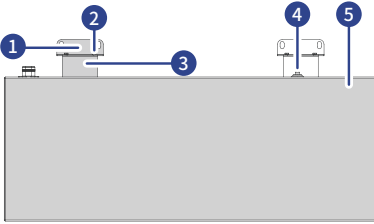

Battery front view

- 1 Mounting Bracket
- 2 Connecting Screw
- 3 Battery Bracket
- 4 Positioner (male)
- 5 Front Panel

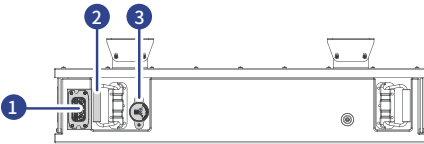

Battery top view

- 1 Top plug connector
- 2 Carrying handle
- 3 Explosion-proof Pressure Relief Valve

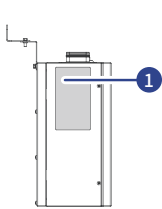

Battery left view

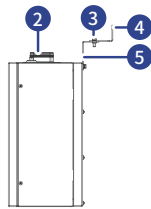

Battery right view

- 1 Label Paste Position
- 2 Top Plug Connector
- 3 Connecting Screw
- 4 Mounting Bracket
- 5 Battery Module Mounting Bracket

### 3.5.4 Base

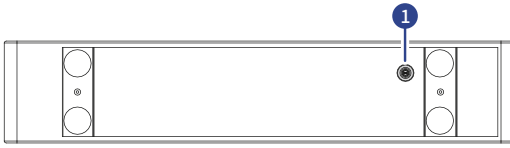

Base bottom view

- 1 Positioner (male)

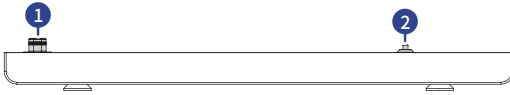

Base front view

- 1 Top plug connector
- 2 Positioner (male)



Base top view

- 1 Top connector
- 2 Positioner (male)

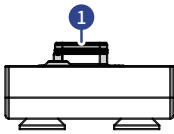

Base right view

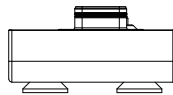





Base left view

- 1 Top plug connector

### 3.6 LED Lights Display Define















#### 3.6.1 Battery System LED Display Define

Table1 LED display description

State	Description	RUN 	ALARM 	FAULT 	Battery SOC indicator 	Discription
					off	Total extinction
Battery system power-up	Normal	on	off	off	Based on real SOC power indication	Standby mode
	Warning	on	Blinking2	off		Equipment is operational but requires maintenance
	Fault	off	off	Blinking3		Device not functioning

Remark: Except for PCS leakage current failure, the FAU lamp is shining, and other faults are ALM light shining.

Table 2 Battery SOC LED Lights Description

State	Charge mode					Discharge mode					Standstill mode				
	L1	L2	L3	L4	L5	L1	L2	L3	L4	L5	L1	L2	L3	L4	L5
SOC LED lights															
SOC	0~20%	One by one light up	Off	Off	Off	Off	Blinking <sub>3</sub>	Off	Off	Off	Off	On	Off	Off	Off
	20%~40%	One by one light up	Off	Off	Off	On	Blinking <sub>3</sub>	Off	Off	Off	On	On	Off	Off	Off
	40%~60%	One by one light up	Off	Off	On	On	Blinking <sub>3</sub>	Off	Off	On	On	On	On	Off	Off
	60%~80%	One by one light up	Off	On	On	On	On	Blinking <sub>3</sub>	Off	On	On	On	On	On	Off
	80%~100%	One by one light up	On	On	On	On	On	Blinking <sub>3</sub>	On	On	On	On	On	On	On

Remark: When the battery is fully charged to 100%, the static 30s will turn into a static state, that is, the capacity lamp is a constant.

Table 3 Description of LED Blinking

Type	On	Off
Blinking1	0.25s	3s
Blinking2	0.5s	2s
Blinking3	0.75s	1s
One by one light up	0.5s Forward one frame	

### 3.6.2 Inverter LED Display Define

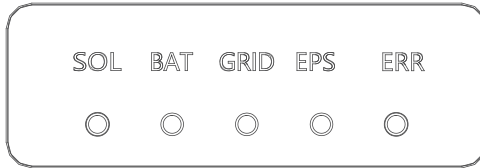

Name of LED	State of LED	Description
SOL	ON	PV is active
	BLINK	PV is standby
	OFF	PV loss
BAT	ON	Battery is active
	BLINK	Battery is standby
	OFF	Battery loss
GRID	ON	Grid is active
	BLINK	Grid is standby
	OFF	Grid loss
EPS	ON	EPS is active
	BLINK	EPS is overload
	OFF	EPS loss
ERR	ON	Fault state
	BLINK	Warning
	OFF	No fault

## 4 Installation

---



### Notice

Please be cautious about unpacking the battery, otherwise components could be damaged.

---

### 4.1 Check for Physical Damage

Make sure the inverter is intact during transportation. If there is any visible damage, such as cracks, please contact your dealer immediately.

### 4.2 Equipment Installation

#### Installation Precaution

HiEnergy series is designed for outdoor installation (IP 65). Make sure the installation site meets the following conditions:

- Not in direct sunlight.
- Not in areas where highly flammable materials are stored.
- Not in potential explosive areas.
- Not in the cool air directly.
- Not near the television antenna or antenna cable.
- Not higher than altitude of about 2000m above sea level.
- Not in environment of precipitation or humidity (>95%).
- Under good ventilation condition.
- The ambient temperature in the range of -20°C to +55°C.
- The slope of the wall should be within  $\pm 5^\circ$ .
- The wall hanging the inverter should meet conditions below:
  1. Solid brick/concrete, or strength equivalent mounting surface;
  2. Inverter must be supported or strengthened if the wall's strength isn't enough (Such as wooden wall, the wall covered by thick layer of decoration)

**Physical environment:** The product design meets IP65 standards, its can be installed indoors or outdoors, ensuring stability and reliability.



Please avoid direct sunlight, rain exposure, snow laying up during installation and operation.



No direct sunlight



No rain exposure



No snow accumulation

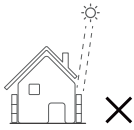

Direct sunlight



Rain exposure



Snow accumulation

#### 4.2.1 Requirement

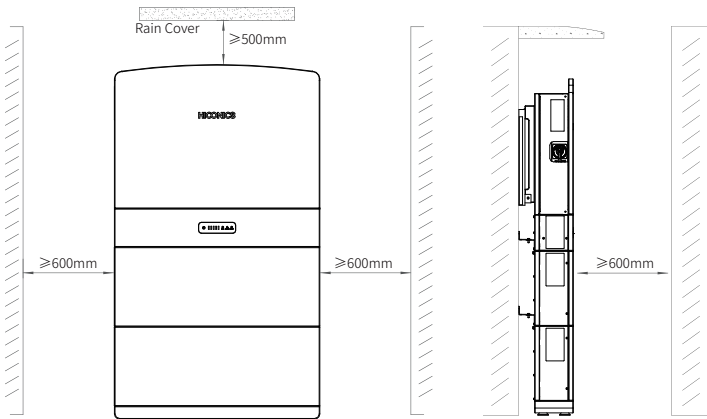















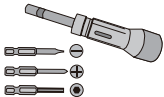
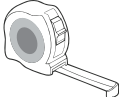

Position	Min size
Left	600mm
Right	600mm
Top	500mm
Front	600mm

#### Mounting Steps

**Note:** The inverter mount can be stacked on its battery.

### 4.2.2 Required for Installation

Installation tools: crimping pliers for binding post and RJ45, screwdriver, manual wrench etc.

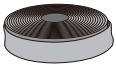
Installation tools			
 Impact Drill (Φ10mm drill)	 Torque Socket Wrench	 Marker Pen	 Vacuum Cleaner
 PV Plug Unlocking Tool	 Torque Screwdriver	 Steel Tape	 Level Ruler
 Electric Batch (with M6 socket)	 Multimeter	 Rubber Mallet	 Wire Stripper
 Wire Cutting Pliers	 Crimping Pliers (for PV terminals)	 Art Knife	 RJ45 Crimping Pliers
 Crimping Pliers (for AC terminals)	 Cable Ties	 Hot Air Gun	 Heat Shrink Tube

## Personal Protective Equipment



Safety Gloves



Safety Goggles

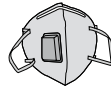

Dust masks



Safety shoes

## 4.3 Installation Process

### 4.3.1 Battery Pack Installation

The battery pack height must comply with local regulations. If the positioning plate conflicts with the regulations, the regulations must be met first.



#### Notice

The installation foundation must be a cement hardened floor.

### Preparation before installation

Open the box, take out the base, PACK, BMS control box, inverter, packing accessories respectively, and prepare the required tools for installation.

## 01 Drilling Holes for Battery Pack Positioning

### Adjust the Base

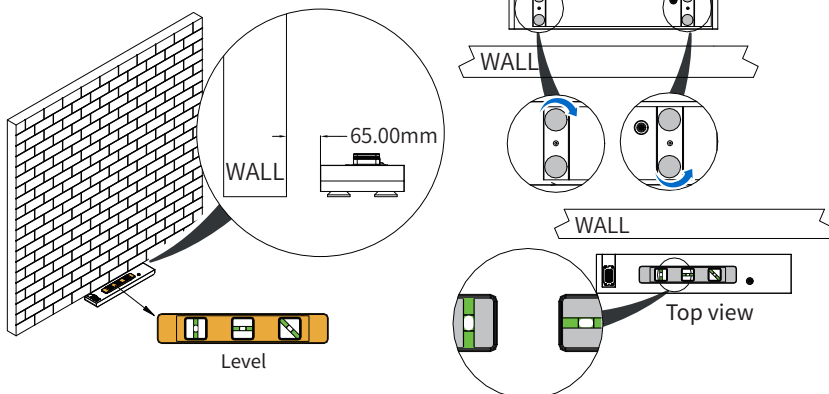

### Drilling positioning

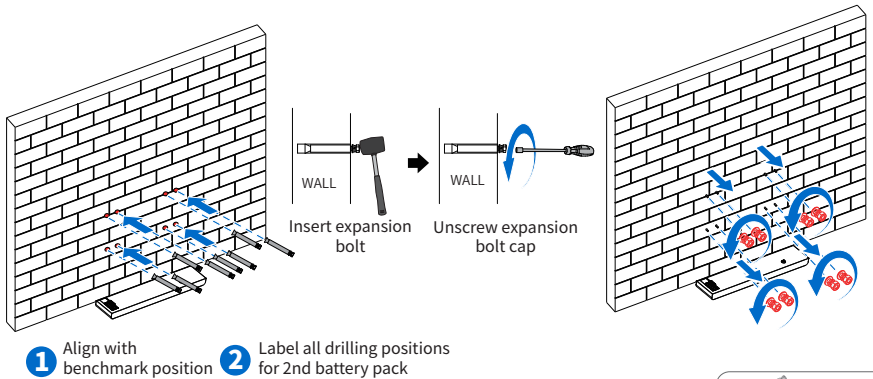
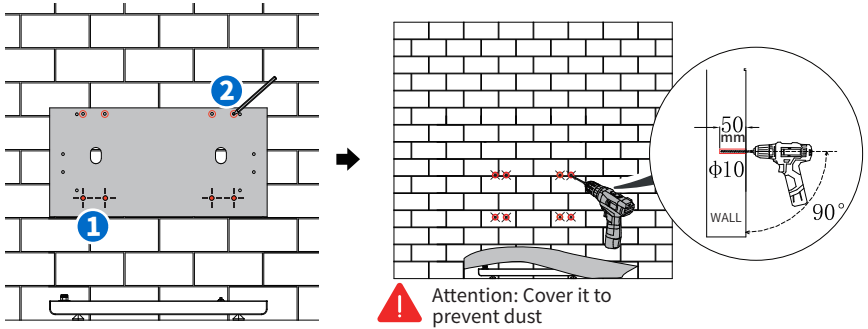
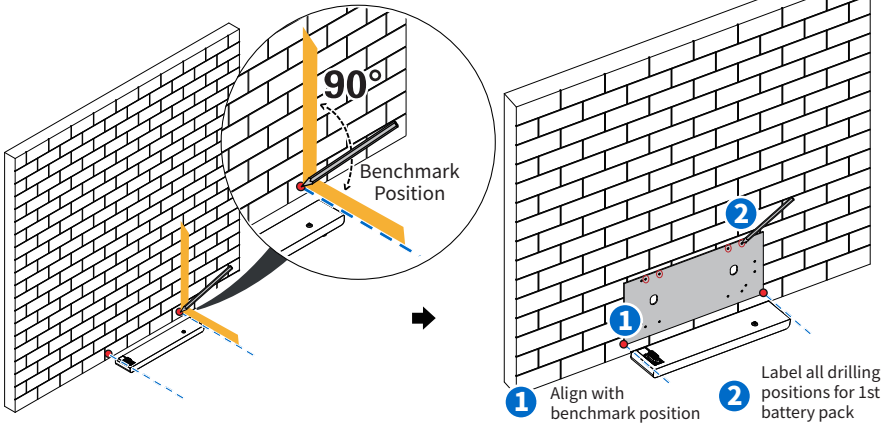

## 02 Installing Battery Pack

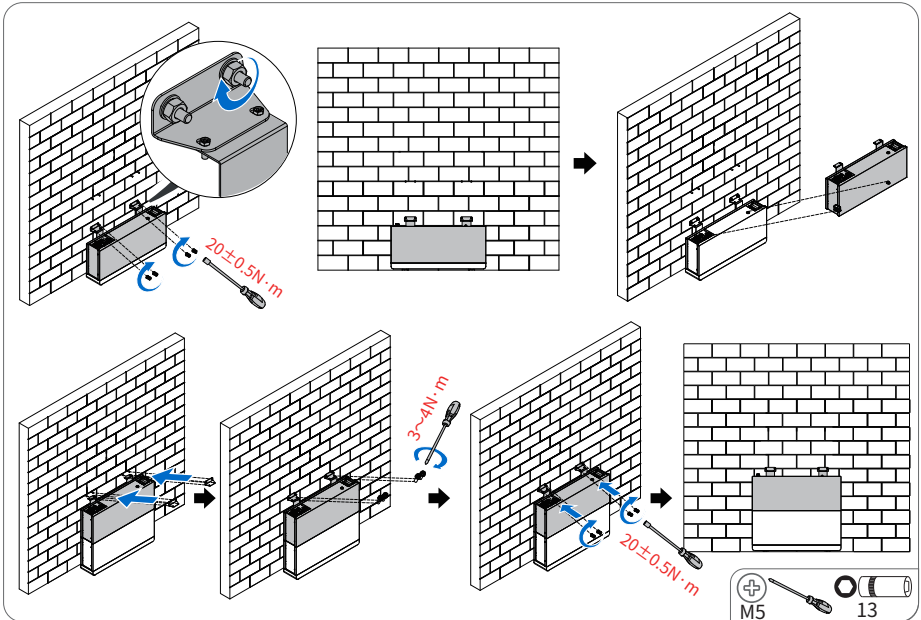
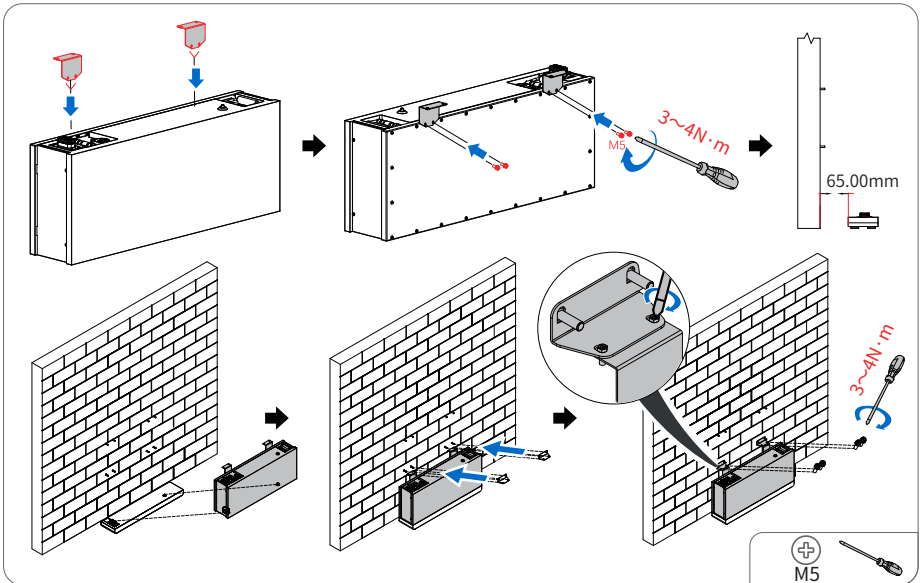

### 03 Installing BMS Control Box

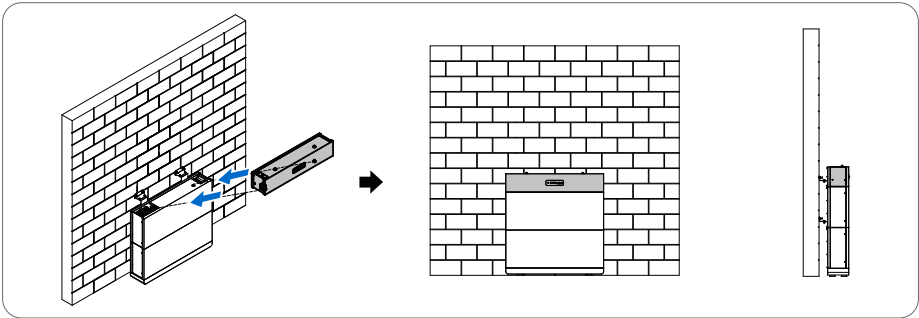

### 04 Drilling Holes for Inverter Positioning

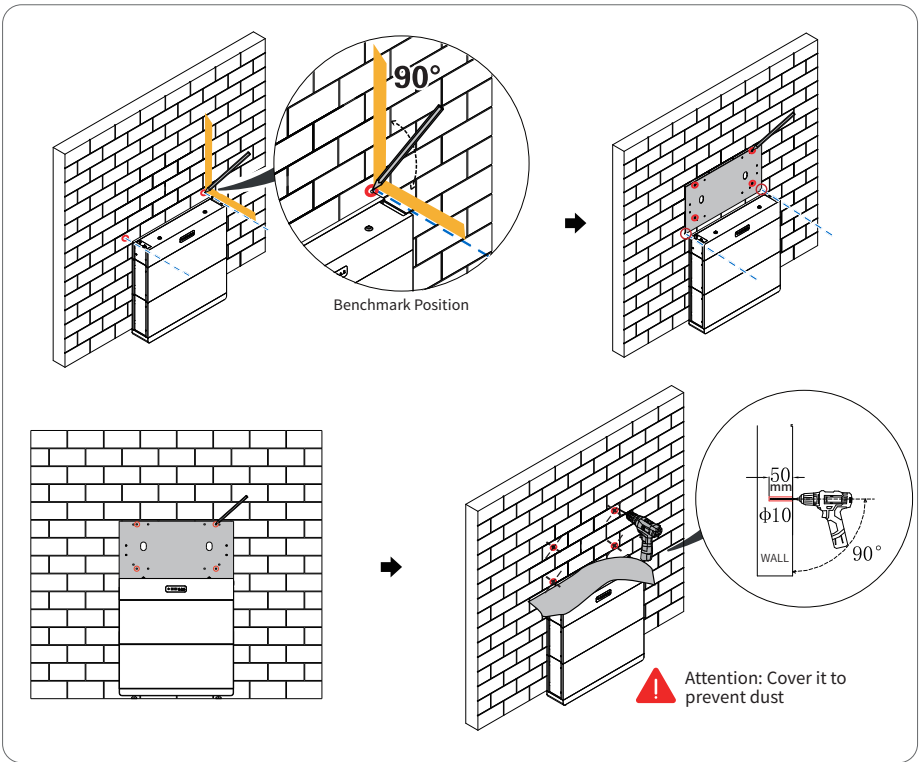

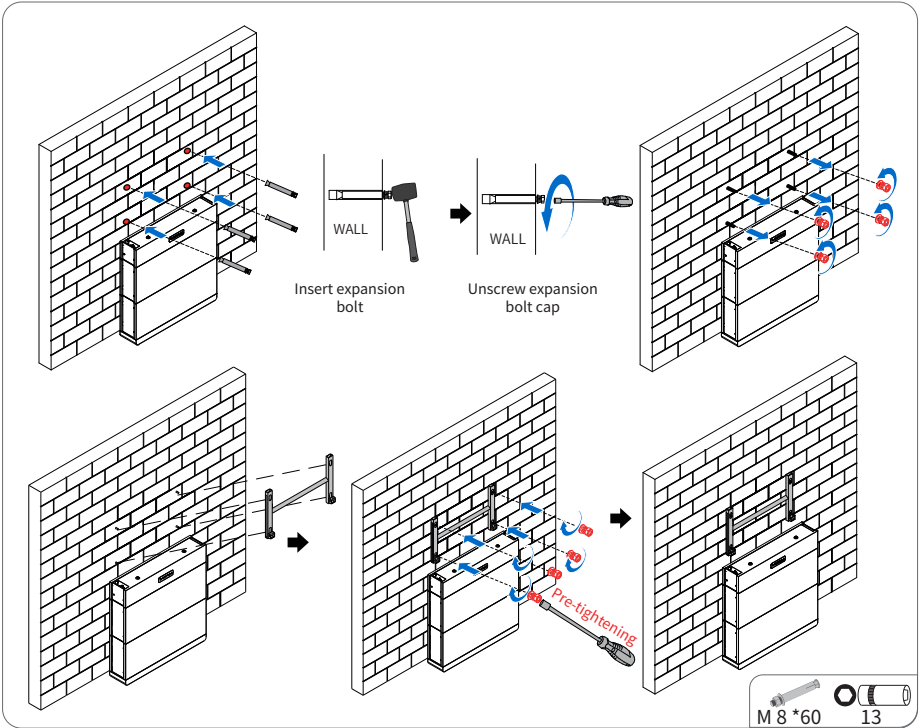

## 05 Installing Inverter

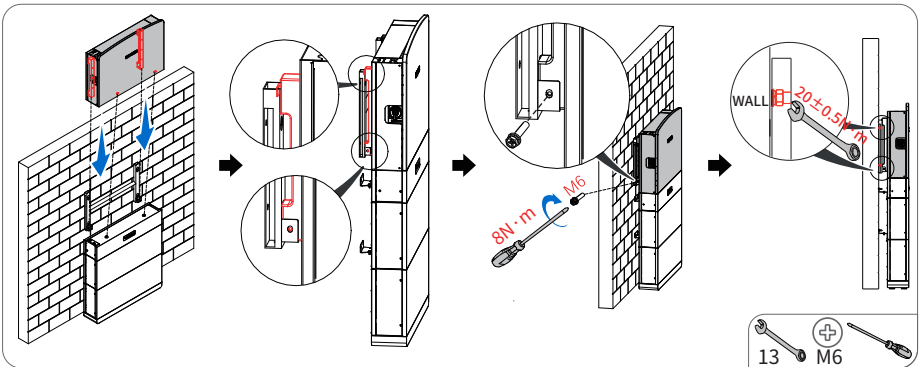

## 5 Electrical Connection

### 5.1 Battery System Cable Connection

The HEC2 RESS system (without inverter) is cableless installation design which includes pre-installed internal connections. The modular stack installation directly plug-in and completes the series connection between battery modules. The connection between the confirm from R&D about the BMS box model number system (from BMS main box) and the inverter requires a cable connection using PCS-BAT connector which includes power connection, communication and grounding. Also, there's a separate grounding connection between BMS main box and inverter.

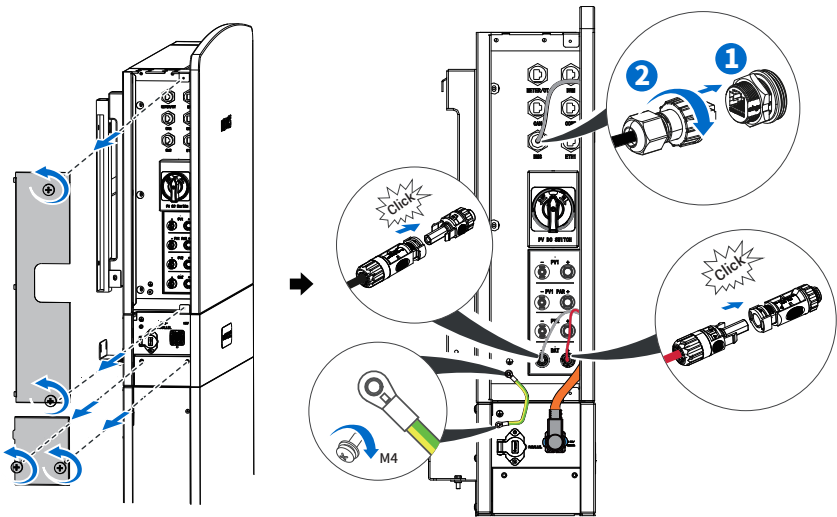

### 5.2 PV Connection



**Warning!**

- Before connecting to PV modules, please install a separate DC circuit breaker between inverter and PV modules. In final installation, breaker certified according to IEC 60947-1 and IEC 60947-2 shall be installed with the equipment.
- It is very important for system safety and efficient operation to use appropriate cable for PV module connection. To reduce risk of injury, please use the proper recommended cable size as below.

Wire Size	Sectional Area (mm <sup>2</sup> )
12AWG	4



- To avoid any malfunction, do not connect PV module with a potential for current leakage to the inverter. For example, grounded PV modules will cause current leakage. When connecting PV modules, make sure that they are NOT grounded.



### Warning!

- It is recommended to use a PV junction box with surge protection. Otherwise, if lightning strikes the PV modules, it will cause damage to the inverter.
- When choosing the right PV modules, please be sure to take the following parameters into account:
  - 1) Open circuit Voltage (Voc) of PV modules not exceeds max. PV array open circuit voltage of inverter.
  - 2) Open circuit Voltage (Voc) of PV modules should be higher than min. start voltage.

### Max. DC Voltage Limitation

Model	HEC2-T15.0Hr2-Eu	HEC2-T12.0Hr2-Eu	HEC2-T10.0Hr2-Eu	HEC2-T8.0Hr2-Eu
Max. DC Voltage (V)	1000	1000	1000	1000
MPPT Voltage Range (V)	180-950	180-950	180-950	180-950

## 5.2.1 Connection Steps:

### Step 1: Checking PV module.

- 1.1 Use voltmeter to measure module array voltage.
- 1.2 Check the PV+ and PV- from the combiner box of PV string correctly.
- 1.3 Make sure that the resistance between the positive/negative pole of PV and earth should be in the M $\Omega$  range.
- 1.4 The PV module connected to the inverter should be rated Class A or Class II according to IEC 61730

### Step 2: Separating the PV connector.

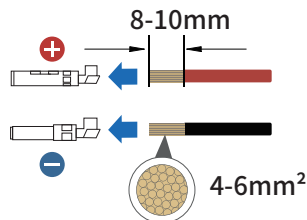

**Step 3: Wiring**

- 3.1 Choose the 4 mm<sup>2</sup> wire to connect with the cold-pressed terminal.
- 3.2 Strip 10mm insulation from the end of the wire.
- 3.3 Insert the wire into pin contact and use crimping plier to clamp it.

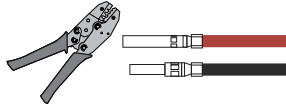

**Step 4:** Insert pin contact through the cable nut to assemble into back of the male or female plug. When you feel or hear a “click” sound the pin contact assembly is seated correctly.

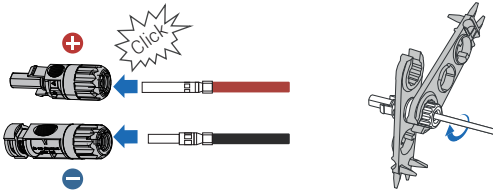

**Step 5:** Plug the PV connector into the corresponding PV interface on inverter.

**5.3 AC Grid Connection**

Before connecting to AC input power source, please install a separate AC breaker between inverter and AC input power source. This will ensure the inverter can be securely disconnected during maintenance and fully protected from over current of AC input. In final installation, breaker certified according to IEC 60947-1 and IEC 60947-2 shall be installed with the equipment.

**Table Cable and Micro-breaker recommended**

Model	HEC2-T15.0Hr2-Eu	HEC2-T12.0Hr2-Eu	HEC2-T10.0Hr2-Eu	HEC2-T8.0Hr2-Eu
AC Grid Cable	10mm <sup>2</sup>	10mm <sup>2</sup>	10mm <sup>2</sup>	6mm <sup>2</sup>
AC Grid Breaker	40A/4P	40A/4P	40A/4P	32A/4P

The material and cross-sectional area of the ground wire are the same as those of the phase wire.



**Warning!**

There are "L1" "L2" "L3" "N" "PE", Symbols marked inside the connector, the Live wire of grid must be connected to "L1" "L2" "L3" terminal; the Neutral wire of grid must be connected to "N" terminal; the Earth of grid must be connect to "PE"

## 5.4 BACK UP

Before connecting the load device, please install a separate AC circuit breaker between the inverter and the load device. This will ensure that the load equipment can be safely disconnected during maintenance and fully protected from the impact of AC input overcurrent. The recommended models of AC breakers are as below:  
In final installation, breaker certified according to IEC 60947-1 and IEC 60947-2 shall be installed with the equipment.

**Table Cable and Micro-breaker recommended**

Model	HEC2-T15.0Hr2-Eu	HEC2-T12.0Hr2-Eu	HEC2-T10.0Hr2-Eu	HEC2-T8.0Hr2-Eu
AC Load output Cable	6mm <sup>2</sup>	6mm <sup>2</sup>	4mm <sup>2</sup>	4mm <sup>2</sup>
AC Load output breaker	32A/4P	32A/4P	25A/4P	20A/4P

PE wire material, cross-sectional area is 10mm<sup>2</sup>.

### Required for installation

Installation tools: open-end wrench, wire stripper, 2.0 Allen driver, 6-side Rivet pliers, etc.

### Installation tools



open-end wrench



wire stripper



2.0 Allen driver



6-side Rivet pliers

**a:** Use professional tools to peel off the cables.

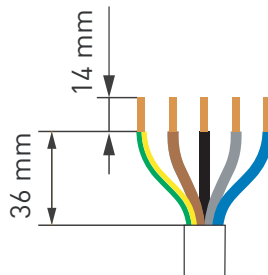

The AC connector is internally marked with five connection ports "1 2 3 N PE", where the live wire is connected to the "1 2 3" terminal, the neutral wire is connected to the "N" terminal, and the earth wire is connected to the "PE" terminal.

—: “CAUTION:NOT FOR INTERRUPTING CURRENT” and “ATTENTION: NE PAS UTILISER POUR COUPER LE COURANT”

—.“Not for Current Interrupting”

**b:** Insert the conductor into the suitable ferrule acc. to DIN 46228-4 and crimp the contact.

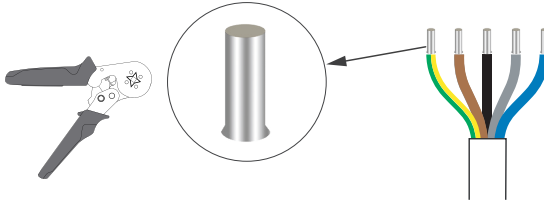

6mm<sup>2</sup> Non-insulated cord end Terminal Recommended

**c:** Remove the AC connector from the accessory pack and twist the ends apart as shown; first twist the body shell D away from the wire body E; then twist the nut away from the body shell.

**Dismantle connector**

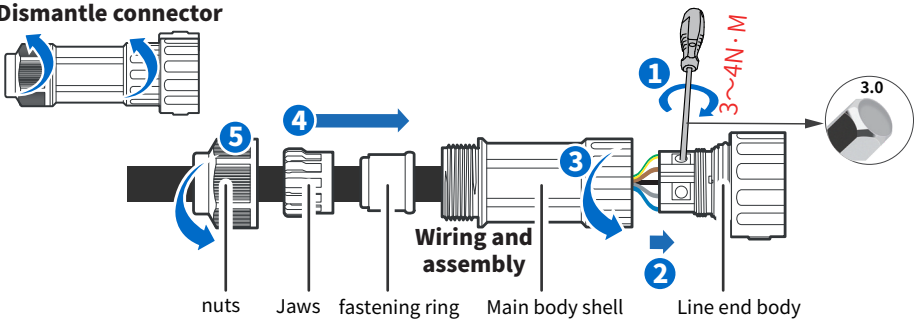

**d:** Plug the AC cable into the AC connector. Refer to step "C" for wire stripping dimensions, pass the cable through the nut and jaw, the main body shell, and insert the stripped cable into the corresponding screw crimp male pins and lock the screws. Note, "C", "D" two fastening rings, according to the different cable diameter, please select the appropriate combination of methods

"C" for cables with an external diameter of  $\varnothing 13\text{mm}-\varnothing 17\text{mm}$   
 "D" is suitable for cables with an external diameter of  $\varnothing 17\text{mm}-\varnothing 22\text{mm}$ .

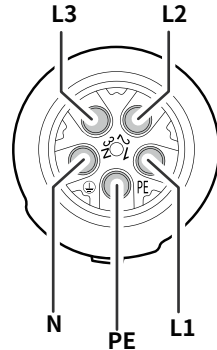

**e:** Assemble the AC connector with the cable connected and tighten both ends; screw the body shell to the end of the cable main body; then screw the nut to the main body shell with a torque of 3~4N.m.

**f:** Connect the assembled AC connector to the AC port of the inverter tighten and hear a click.

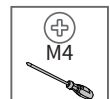
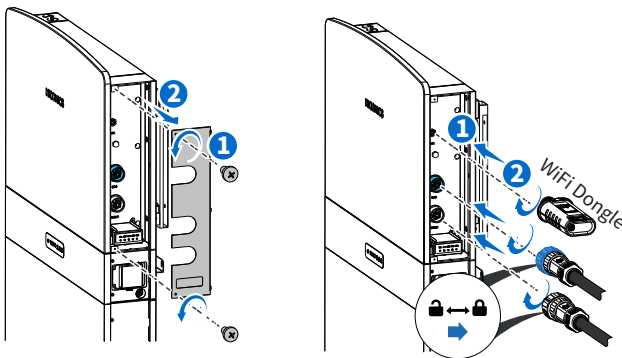

## 5.5 Communication Interface Connection

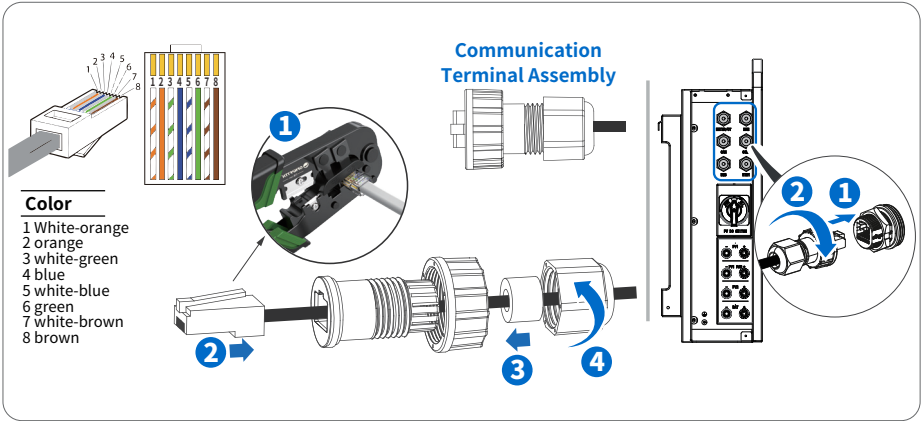

### 5.5.1 METER/CT Interface

The electricity meter should be mounted and connected at the grid transition point (feed-in point) so that it can measure the grid reference and feed-in power.

(1) Loosen the nut, and untangle the single-aperture sealing ring.

Pin	Description	Pin	Description
1	CT1B	5	CT3A
2	CT1A	6	CT2B
3	CT2A	7	485B
4	CT3B	8	485A

\*Refer to 5.5 for wiring sequence.

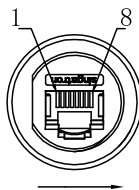

Interface Description

(2) Install the waterproof component and screw on the waterproof sheath nut.

(3) Open the external CT wiring port, the arrow points to the direction of the power grid, put the wire into the external CT card slot, and buckle the buckle.

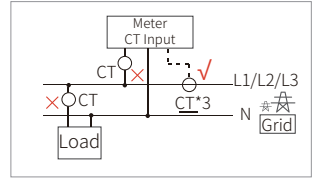
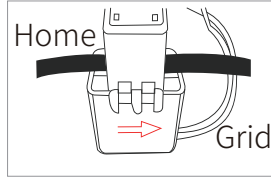
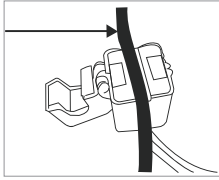

### Notice

External CT should be placed near the power grid.

If CT test pass but inverter still can't achieve export power (power is not controllable or always 0 power output). Please check installation location of the CT.

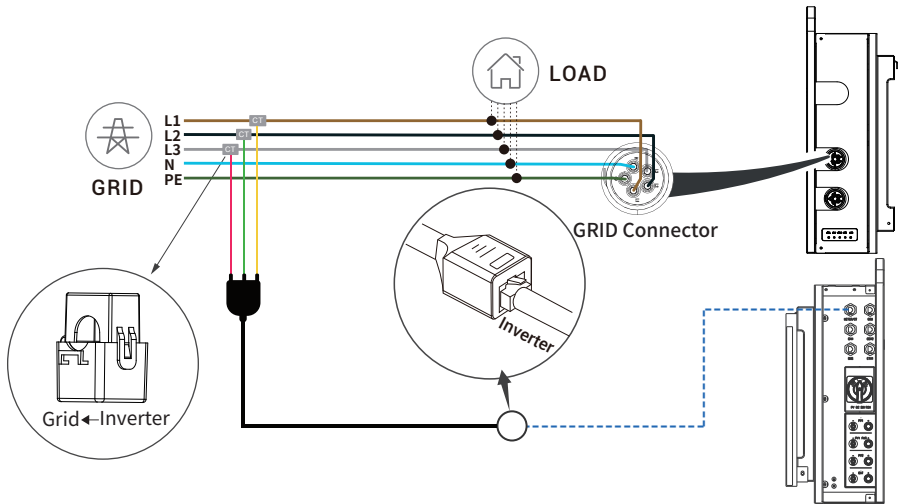

## 5.5.2 DRM Interface (Optional)

This interface is a dry contact (only for Australia)

DRM means demand response enable device. The AS/NZS 4777.2:2020 required inverter need to support demand response mode (DRM). This function is for inverter that comply with AS/NZS 4777.2:2020 standard. Inverter is fully comply with all DRM. A RJ45 is used for DRM connection.

Pin	Description	Pin	Description
1	DRM1/5	5	DRM0
2	DRM2/6	6	N/A
3	DRM3/7	7	GND
4	DRM4/8	8	GND

\*Refer to 5.5 for wiring sequence.

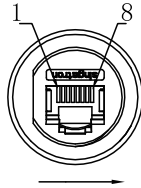

Interface Description

### DEMAND RESPONSE MODES (DRMs)

Mode	Requirement
DRM 0	Operate the disconnection device
DRM 1	Do not consume power
DRM 2	Do not consume at more than 50% of rated power
DRM 3	Do not consume at more than 75% of rated power AND Source reactive power if capable
DRM 4	Increase power consumption (subject to constraints from other active DRMs)
DRM 5	Do not generate power
DRM 6	Do not generate at more than 50% of rated power
DRM 7	Do not generate at more than 75% of rated power AND Sink reactive power if capable
DRM 8	Increase power generation (subject to constraints from other active DRMs)

### 5.5.3 CAN Interface

Communication reserved interface

Pin	Description	Pin	Description
1	MCAN-TX-H	5	CAN1-L
2	MCAN-RX-L	6	NA
3	NA	7	NA
4	CAN1-H	8	NA

\*Refer to 5.5 for wiring sequence.



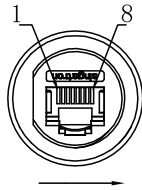

Interface Description

### 5.5.4 COM2 Interface

Communication reserved interface

Pin	Description	Pin	Description
1	VCC	5	485B
2	GND	6	485A
3	N/A	7	DO1B
4	N/A	8	DO1A

\*Refer to 5.5 for wiring sequence.

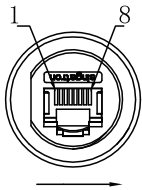

Interface Description

### 5.5.5 BMS (to BMS Control Box) Interface

This interface is a communication interface between BMS and INV. The communication between INV and BMS is RS485 and CAN.

Pin	Description	Pin	Description
1	N/A	5	485B
2	GND	6	485A
3	N/A	7	CAN0-H
4	N/A	8	CAN0-L

\*Refer to 5.5 for wiring sequence.

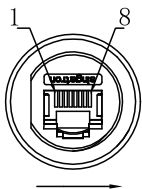

Interface Description

### 5.5.6 ETH1 Interface

This interface is a communication interface between gateway of customer and INV.

Pin	Description	Pin	Description
1	485B	5	N/A
2	485A	6	N/A
3	N/A	7	N/A
4	N/A	8	N/A

\*Refer to 5.5 for wiring sequence.

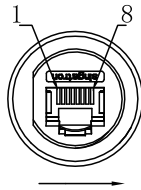

Interface Description

### 5.6 External Smart Meter Connection

You must connect external CTs or a smart grid meter between the inverter and the power grid. If you want to connect a smart meter, note that only one meter is necessary for each inverter. The meter must be mounted and connected at the grid transition point (feed-in point) so that it can measure the grid reference and feed-in power.

#### PROCEDURE

**STEP1:** Prepare the communication wires, power cable, and tools for the meter connection.

**STEP2:** Selection of a suitable position location for fixing the DIN track, Mount the Meter on the DIN track.

**STEP3:** Installation of CT. Refer to the introduction of CT installation for specific steps.

**STEP4:** Install the cables correctly as shown.

(The fuse in the wiring diagram is recommended 0.5 A to 3A.)

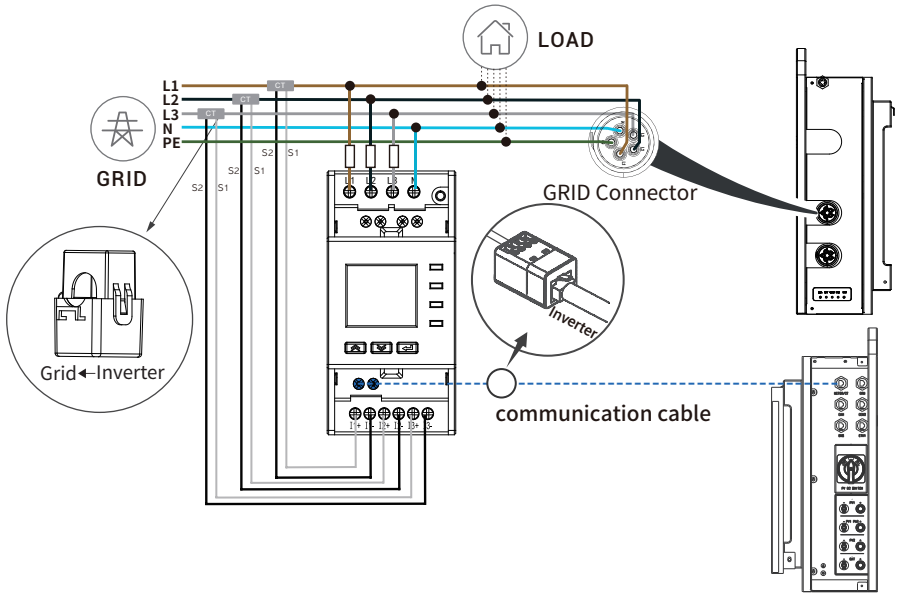

Wiring of Smart Meter Connection , Example: ACR10RH-D16TE4 (120A)



### Notice

- Here are two versions of CT cables' colour.  
Version 1: S1-White, S2-Black  
Version 2: S1-Red, S2-Black
- The fuse in the wiring diagram is recommended 0.5 A to 3A.  
The actual product shall prevail!

### 5.7 Earth Fault Alarm Connection

The inverter complies with IEC 62109-2 13.9. The fault indicator LED on the inverter cover will light up and the app will push a message of an error code of F40 indicating the earthing fault.

The inverter should be installed at eye level for convenient maintenance (Adjust the height by placing the foundation).

### 5.8 Wiring Diagram

For Australia, New Zealand. The neutral points on the GRID side and the LOAD side must be connected together, otherwise the LOAD function does not work.

PE grounding:

1. The PE terminal of LOAD is vacant and cannot be connected to the grid system of Australia, New Zealand and South Africa.
2. There are two PE earthing posts on the inverter shell, one is connected to the shell earthing post of the BMS control box to maintain earthing continuity between different structural parts, and the other PE earthing post needs to be reliably connected to the building earthing ring network nearby.

### Australia Wiring

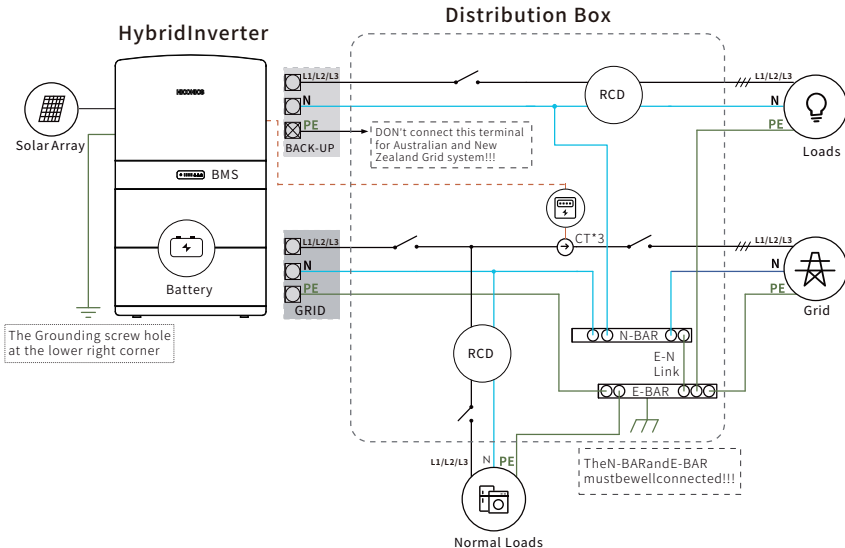

## European Wiring

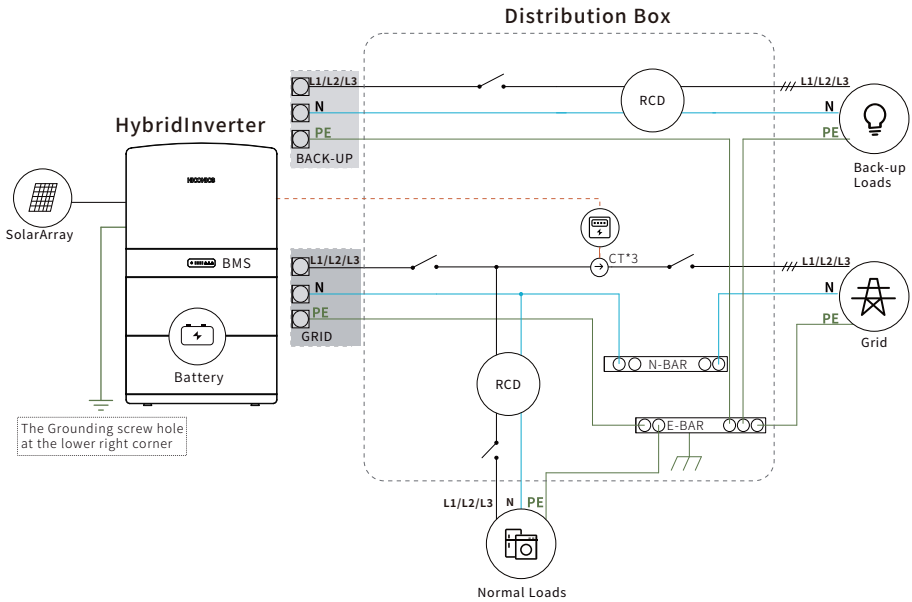

### 5.9 Expansion of Battery Capacity

- Capacity 10.2 kWh: 2 × battery module + 1 × BMS control box + 1 × base
- Capacity 15.3 kWh: 3 × battery module + 1 × BMS control box + 1 × base
- Capacity 20.4 kWh: 4 × battery module + 1 × BMS control box + 1 × base
- Capacity 20.4 kWh: 4 × battery module + 2 × BMS control box + 2 × base
- Capacity 30.6 kWh: 6 × battery module + 2 × BMS control box + 2 × base
- Capacity 40.8 kWh: 8 × battery module + 2 × BMS control box + 2 × base

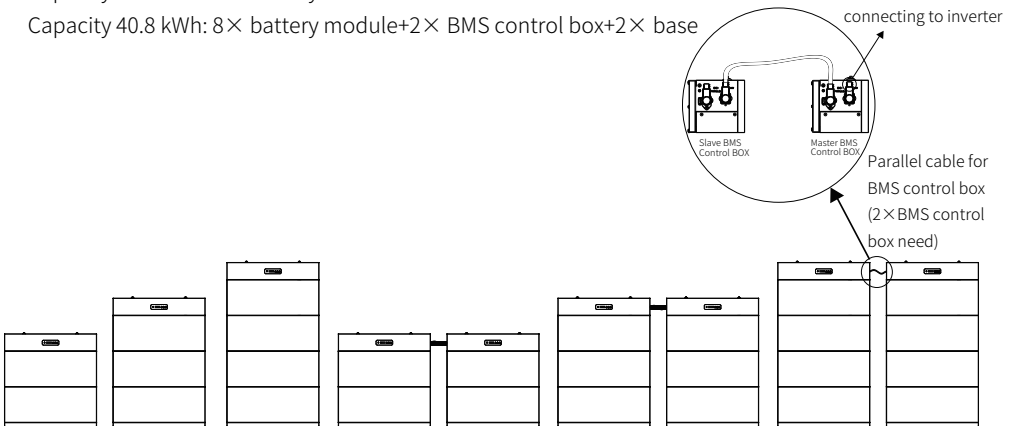

Installed in troughs or protected by a metallic cable duct or conduit. The metallic cable duct or conduit, provided that that metallic parts are connected with the equipotential bonding system and comply with IEC62477-2022 clause 4.4.4.2.2



**Warning!**

Parallel cables shall be installed in troughs or protected by metal pipes.

### 5.10 Install the Side Panel

Cable conduit

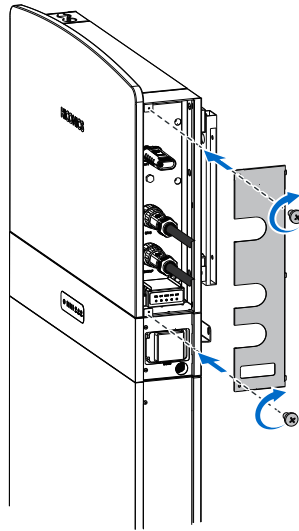
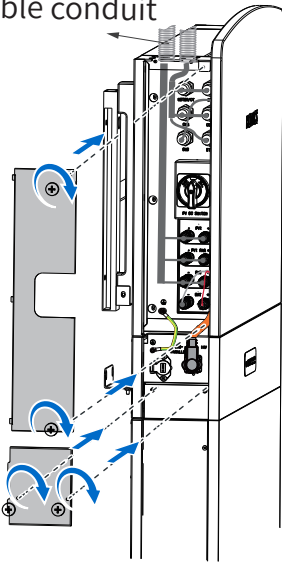

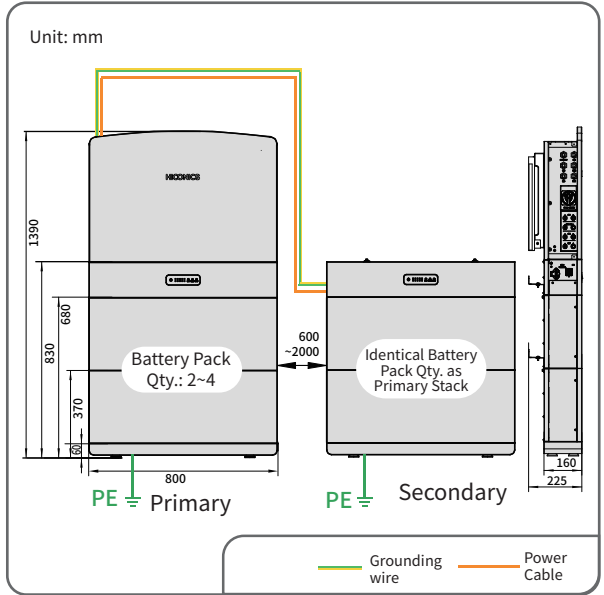
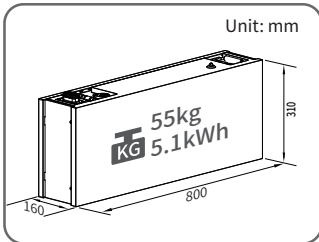
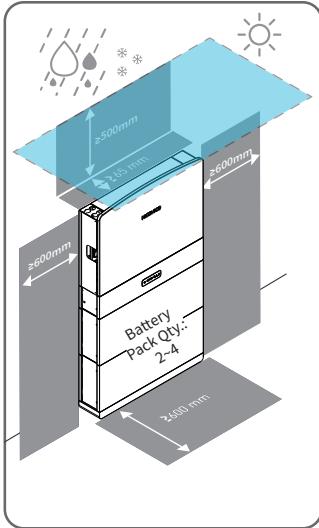

### Overall Effect

## 6 System Operation

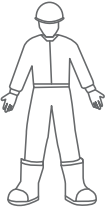

Preparations before turning on/off the machine.

### 6.1 Switch On

When turning on the system, it is very important to follow the steps below to prevent damage to the system.



**Warning!**

Please check the Wiring of cables again before turning on the system.

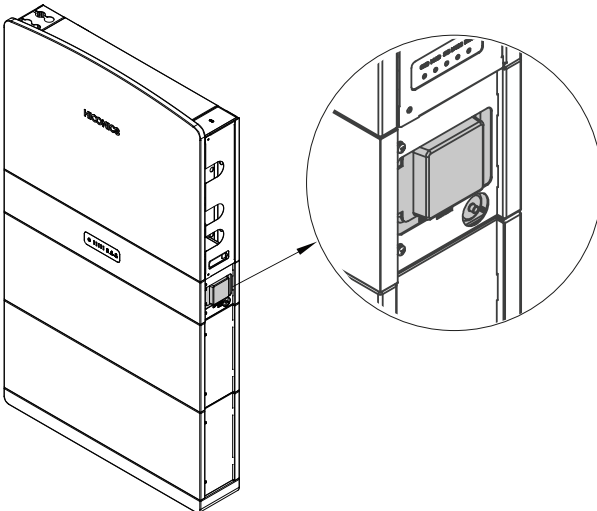



**Step 1:** Open the side shell of the BMS control box. Open the battery breaker cover and turn on the battery circuit breaker.

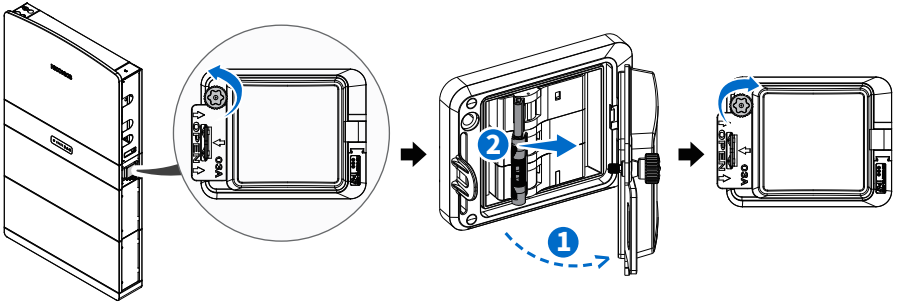

**Step 2:** Press the power button on the BMS control box.

**Step A**

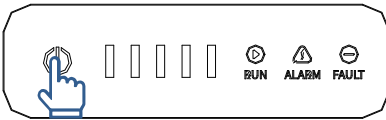

**<1 s (Click)**

**Step B**

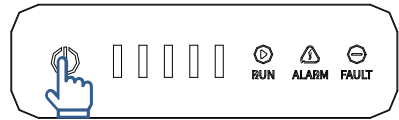

**5~15 s (Long Press)**

**Step A**  $\xrightarrow{<5s}$  **Step B**



When the battery system is switched on, the power button indicator lights up.

### Power Light State:

When RESS is turned OFF, the power light status will be "OFF" . When RESS is turned ON, the power light status will be "ON" . In order to switch "ON" or "OFF" the RESS, we can use the following steps as given below:

### Operation Steps:

- 1: Short press the power button less than 1s, vertical light will flash within 5s;
- 2: Then long press the power button for 5s to 15s, the vertical light will be on for few seconds and turn off and then the power light will turn "ON".

To make sure the steps are correct, power light should be "ON" and vertical light should be "OFF".

If in step2, long press is not within the range of 5s to 15s, the vertical light will flash and power light will remain "OFF";



### Notice

If no effective press again within 5s (While the Vertical light is flashing, and power light is off,), it will be back to the initial state (vertical light will turn "OFF" , and power light is "OFF");

If press effectively again (long press 5s to 15s), the power light will turn "ON" and vertical light will turn "OFF".

**Step 3:** Turn on the PV isolation switch on inverter.

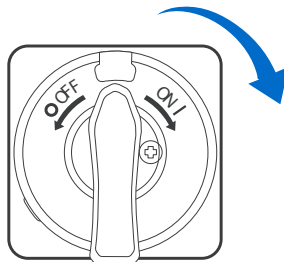

**Step 4:** Turn on the external grid AC circuit breaker.

## 6.2 Switch Off

**Step 1:** Turn off the external grid circuit breaker.

**Step 2:** Turn off the PV isolation switch.

**Step 3:** Press the power button on the BMS control box (Detailed operation instructions refer to 6.1 step2).

**Step 4:** Open the battery circuit breaker cover and turn off the battery circuit breaker.

## 7 Plant Monitoring

### Account Management Guide

**User Permissions:** To use this service for the first time, you need to register an account and password. Please keep your account and password safe.

**Account types:** There are different types of accounts: user accounts and operations personnel accounts. User accounts only have access and view permissions, while operations personnel accounts have access, view, and configuration permissions.

**Modify account and password:** Follow the prompts on the interface to ensure that the password meets the complexity requirements.

**Account lockout:** The account will be locked after multiple failed login attempts, please be careful when operating.

This product adopts a defense-in-depth scheme which includes identity verification, private protocols, authorization mechanisms, security auditing, data encryption, effective resources, and abnormal protection. These 7-layer mitigation measures protect the BESS system's security in connection schemes, operational process data, and operating environment. A brief summary is as follows:

- Identity verification: Use account and password policies to ensure device communication and information security.
- private protocols: Use proprietary function codes and private communication protocols to ensure secure communication between system components.
- Authorization: Only authorized users can access the data.
- Security Audit Tracking: Audit logs that record security activities and sensitive data.
- Encryption of Sensitive Firmware Data.
- Availability of resources: Use fixed resources to run the system to prevent device freeze or crash.
- Abnormal protection: When there is a communication abnormality, users are required to log in and authorize again.
- The product will be connected to solar panels, connected to the grid, and integrated with off-grid loads. Please ensure that all connection ports are correctly connected.
- The product will be connected to an external electricity meter or CT for grid data collection. Please ensure that the collection device is installed correctly and connected to the product.
- The product is designed with a multi-layer defense scheme. Please follow the application and maintenance process accordingly.
- External communication of the product requires an external gateway product. Please ensure that the gateway product has obtained matching permission.
- Unauthorized third-party tools are not supported for security management, monitoring, and event handling of this product.
- A gateway product is required to connect for system firmware upgrades and data transmission.
- Only authorized personnel can perform maintenance using official tools and record maintenance logs.



**Caution**

**Notice**

- Network Environment: This product does not directly connect to the Internet and cannot be used in environments that require network segmentation security support. Use a specific gateway or WiFi module to ensure that the network environment is risk-free.
- Proper operation: Use a strong password to log in and securely log out after using the system.
- Consequences of not following the instructions: It may result in system attacks, data leakage or loss, and affect product operation.

**Caution**

When the device malfunctions, follow the instructions in Chapter 9 according to the error code.

---

## 7.1 Create a Plant (End User Version)

Owners can create your own plant at SOLARMAN Platform to run a real-time monitoring. System will collect the data from associated devices, which enables a full understanding of RESS plant running status.

### Step 1: "Add Now"

Click "Add Now" to create your plant at SOLARMAN Platform.

Notice: If you have already created a plant, you will not see this page. And if you wish to create another plant, please click "+" in the upper-right corner and select "Create a Plant".

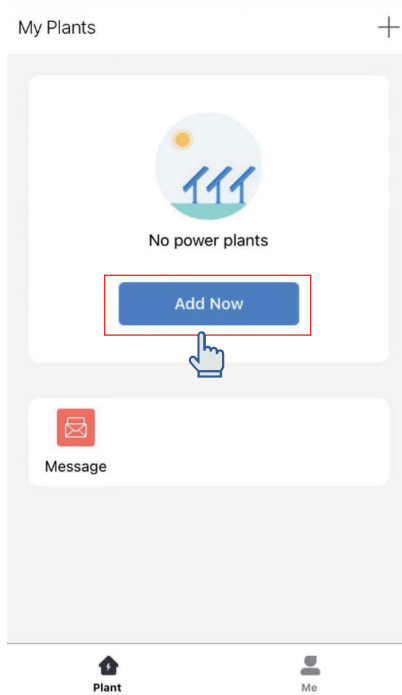

When you enter the following page, please select according to your own situation. If your plant has an installer to do O&M in the later stage, it is recommended that do Not create plant by yourself.

**← Notice**

Dear Owners, do you have an installer to do O&M in the later stage?

Yes
  No

If your plant has an installer to do O&M in the later stage, it is recommended that **do not create plant by yourself**. Please inform your installer of your User ID, then the plant can be created by the installer on Business platform.

Create Plant By Myself

**← Notice**

Dear Owners, do you have an installer to do O&M in the later stage?

Yes
  No

If your plant has no installer to do O&M in the later stage, please click "Create Now".

Create Now

## Step 2: Enter Plant Details

Please enter detailed plant information according to your actual situation. System will create a unique plant for you. In order to calculate plant data precisely, please enter:

- (1) Plant Name;
- (2) Plant Type: Residential Rooftop;
- (3) System Type: Storage System;

**← Select System Type**

network of the user grid company.

Centralized plants are generally used for large areas of industrial and commercial flat land.

---

**Storage System**

Storage system means adding energy storage battery on the basis of photovoltaic system. According to the settings of the platform or equipment, electric energy will flow continuously between power generation, electricity consumption, grid, and batteries through the energy storage system, so as to save electricity expenses without affecting the normal use of electric energy. In some scenarios, the energy storage system is also used as a way to reserve power to solve the problem of sudden power outages.

Expand more system type

Yes

- (4) Plant Location;
- (5) Installed Capacity;
- (6) Time Zone;
- (7) Other information.

**Please notice:**

(1) Click  to switch between Google Maps and Amap. Amap will enhance searching&locating ability in China. Google Maps will enhance searching &locating ability globally. Please select accordingly.

(2) Click  to switch between 2D Plane Map and Satellite Map.

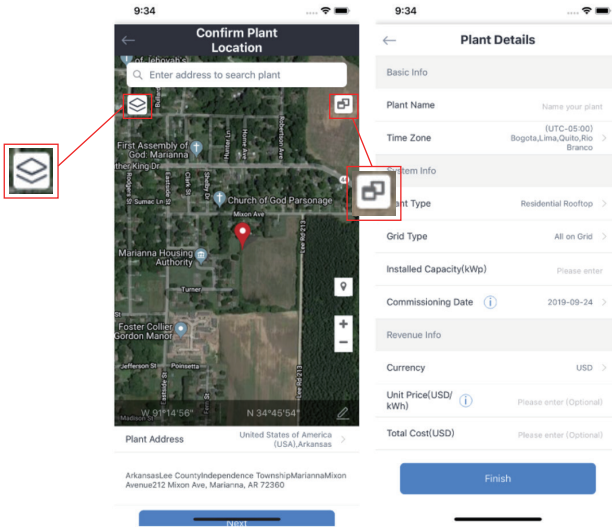

**Notice:** If your plant has no data after you click "Finish", which means there is no device in your plant.

## 7.2 Add a Logger

After the plant is created, you can add a logger. Logger can collect running data from PV devices and upload to server, which enables a full understanding of PV plant running status and revenue information. Furthermore, system will determine whether the plant is running normally, which avoid property losses caused by device failure and other reasons.



### Step 1: Go to add logger

Once the plant is created, you can see the page as below, please click the “Go to Add”

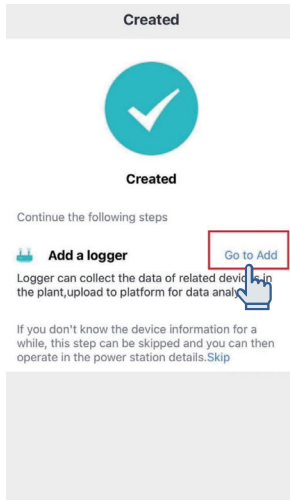

**Notice:** If you have created multiple photovoltaic plant, please select the specific plant you want to add before adding a Logger to avoid data confusion caused by adding equipment to the wrong plant, which affects your judgment of plant operation. At present, there are several ways to Add equipment:

#### 1) Plant Page Add

Click the **【+】** icon on the top right corner of the plant home page to add it. Select “Add a Logger” to enter the plant selection page. Please select the plant you want to add according to your actual situation

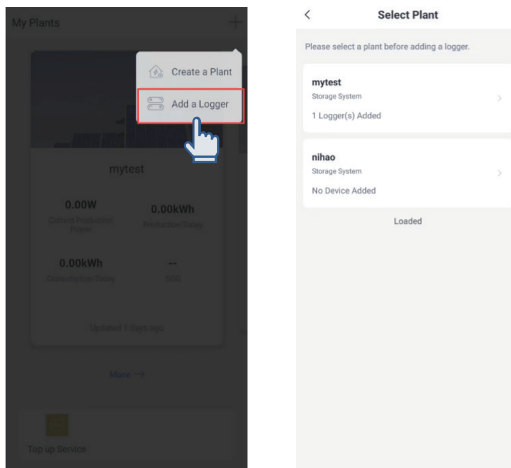

## 2) Plant Equipment List Page Add

On the **【Plant Details】** page of a specific Plant, click the “...” icon at the upper right corner, and select Add a Logger to enter the corresponding page Add a Logger equipment under the Plant.

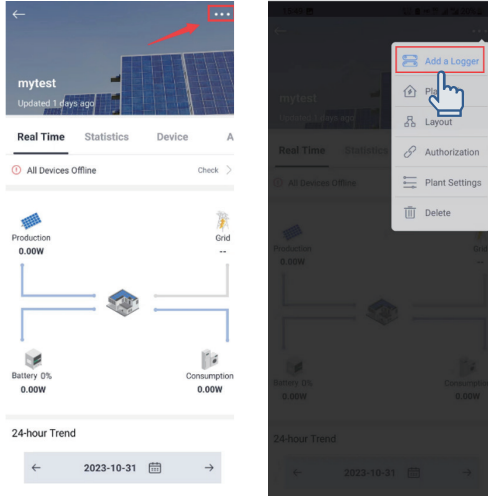

### Step 2: Enter Logger SN

You can enter logger SN manually or click icon in the right to scan SN.

The SN number and the QR code are on the cover of the data dongle, you can find it there.

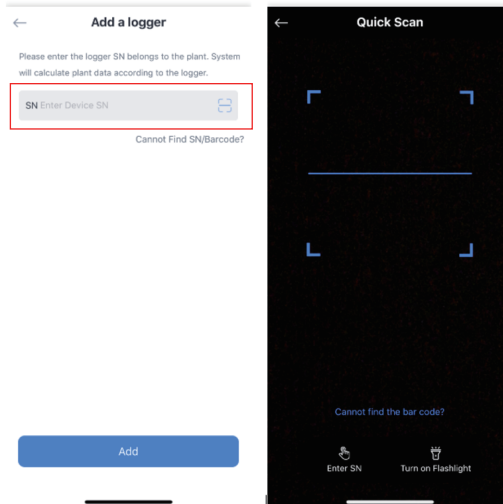

**Notice:** If failed to scan the QR code or the scan result data is different with the SN number in the label, please input SN code manually.

### 7.3 Networking Configuration

After completing the above steps, the APP will display the following interface:

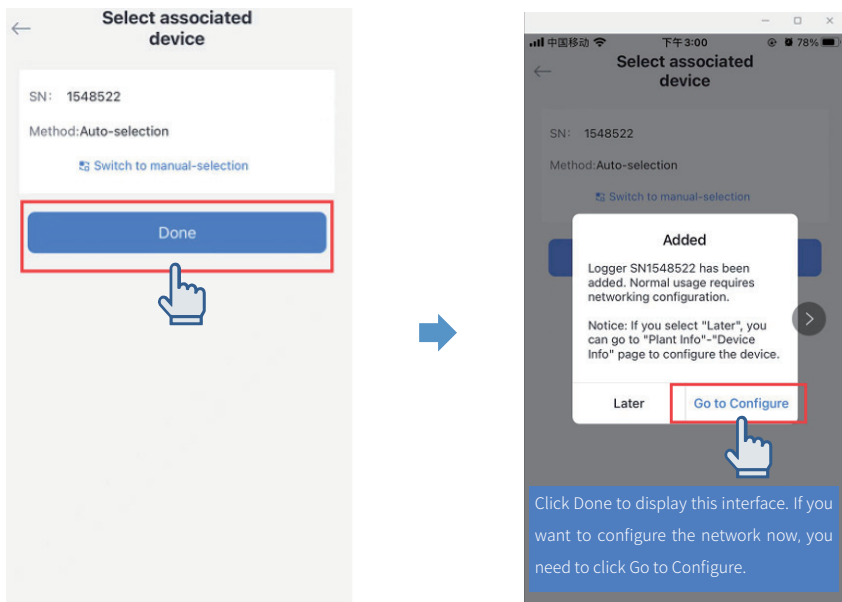

1) The Networking Configuration mainly provides the function operation of the specific communication capability after Device Networking for the Logger equipment of the WI-FI module, so as to facilitate the rapid access to the data of the power station and the acquisition of real-time data.

Once finished add the logger SN, then begin to networking configuration.

#### Step 1: Confirm Wi-Fi Info

Please make sure that your mobile phone is connected to the Wi-Fi network at home, which is consistent with the network displayed on the page, and enter the connection password of the network.

After completing the input and confirming that the password is correct, click the **"Start to configure"** button.



### Step 2: Auto Configuration

Please wait for a while to complete the configuration. System will switch to the Configured Page automatically. Please keep the Wi-Fi and Bluetooth functions of your phone turned on during the configuration process.

When you go back to 「Device List」, the logger will still at **Offline** status. Usually, the data will be updated in 10 mins. Please wait patiently.

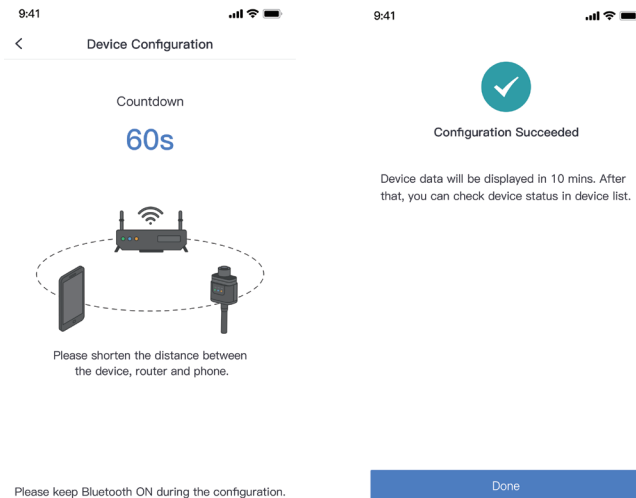

**Notice:** If configuration failure occurs, please check the following reasons and try it again.

1. Make sure WLAN is ON;
2. Make sure Bluetooth is ON;
3. Make sure WiFi is normal;
4. Make sure wireless router does not implement the white-black list;
5. Shorten the distance between the phone and device;
6. Try to connect to other Wi-Fi;
7. Remove the special characters in Wi-Fi network.

2) If you click Later, you can then click Device to proceed with the network configuration. You can check whether the Logger displays the "Device Networking" button on the list page of supporting power station equipment, and repeat step 1、step 2. If not, networking is not required!

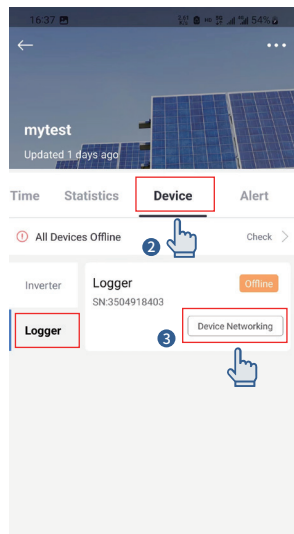
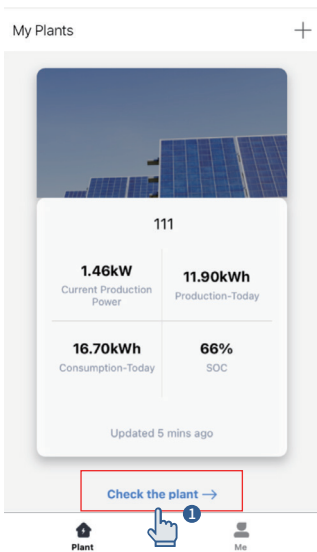

## 8 APP View Data

After the plant and device setup is done, you can check plant data remotely.

**Notice:** Please check plant data 10 minutes later after networking configuration.

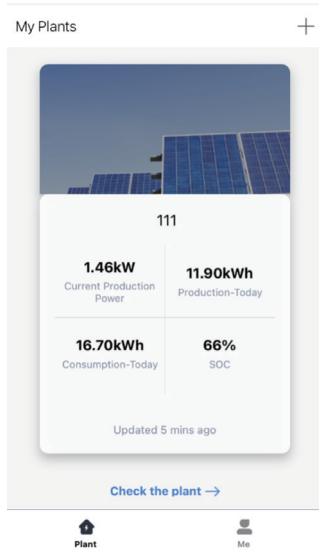

### 8.1 Real Time Data

Click the plant as shown above, you can check various data on this page. E.g. Flow Chart, 24H Curve, Production, Consumption, anticipated yield, etc.

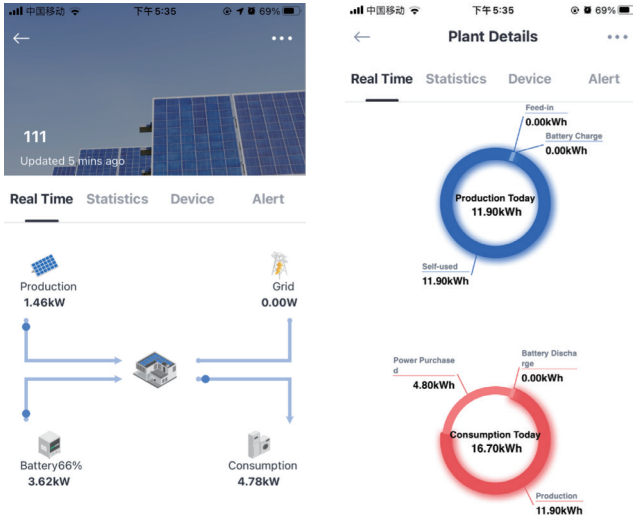

## 8.2 Statistics Data

You can check plant statistics and historical data on this page. You can filter specific date and conditions to query.

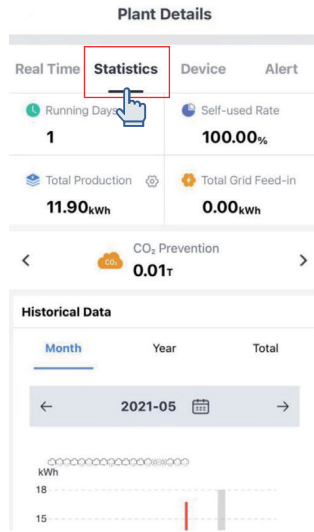

## 8.3 Device Info

Click the button in the upper-right corner to go to "Device Info" page.

You can check device information on this page. Click a specific device to check real-time data and statistical chart, through which you can know if the device is running normally.

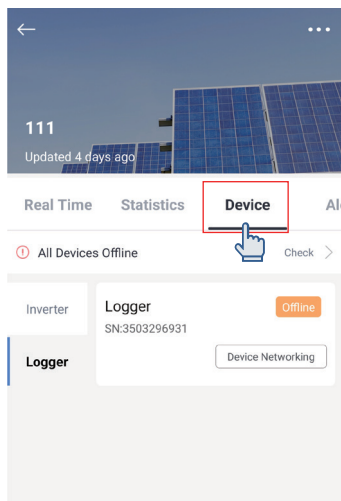

### 8.4 Alert Data

You can check plant alert on this page. Alert will be distinguished from alert importance and alert content, which enables you to understand the importance of alerts. Through these alert message, you can learn the fault status of your plant, which avoids property losses.

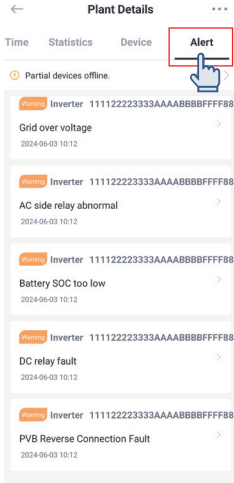

### 8.5 User Manual of Solarman Smart

If you want to know about more details, please follow these steps as below to read the user manual of SOLARMAN Smart:

- 1. Please enter the main page and click "About SOLARMAN Smart"
- 2. Click the "User Manual" to enter the link.

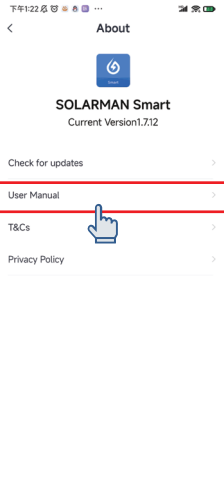
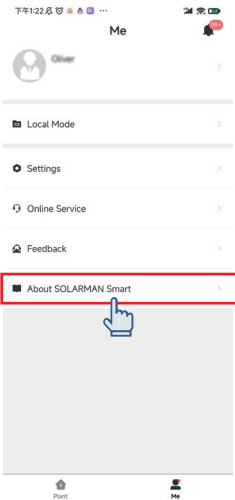



## 9 Fault Information

Fault code	Fault name	Solution
1	NVM checksum failure	Disconnect the AC output switch, DC input switch and Battery switch, then connect them 5 minutes later. Contact the dealer or the after-sales service if the problem persists.
2	DSP communication failure	Disconnect the AC output switch, DC input switch and Battery switch, then connect them 5 minutes later. Contact the dealer or the after-sales service if the problem persists.
3	BMS communication failure	Disconnect the AC output switch, DC input switch and Battery switch, then connect them 5 minutes later. Contact the dealer or the after-sales service if the problem persists.
4	Battery overvoltage alarm	Disconnect the AC output switch, DC input switch and Battery switch, then connect them 5 minutes later. Contact the dealer or the after-sales service if the problem persists.
5	Battery undervoltage alarm	Disconnect the AC output switch, DC input switch and Battery switch, then connect them 5 minutes later. Contact the dealer or the after-sales service if the problem persists.
6	Battery overtemperature alarm	Disconnect the AC output switch, DC input switch and Battery switch, then connect them 5 minutes later. Contact the dealer or the after-sales service if the problem persists.
7	Battery under temperature alarm	Disconnect the AC output switch, DC input switch and Battery switch, then connect them 5 minutes later. Contact the dealer or the after-sales service if the problem persists.
8	Battery overcurrent alarm	Disconnect the AC output switch, DC input switch and Battery switch, then connect them 5 minutes later. Contact the dealer or the after-sales service if the problem persists.
9	Battery voltage difference too large	Disconnect the AC output switch, DC input switch and Battery switch, then connect them 5 minutes later. Contact the dealer or the after-sales service if the problem persists.
10	Temperature difference too large	Disconnect the AC output switch, DC input switch and Battery switch, then connect them 5 minutes later. Contact the dealer or the after-sales service if the problem persists.
11	Battery SOC too high	Disconnect the AC output switch, DC input switch and Battery switch, then connect them 5 minutes later. Contact the dealer or the after-sales service if the problem persists.

12	Battery SOC too low	Disconnect the AC output switch, DC input switch and Battery switch, then connect them 5 minutes later. Contact the dealer or the after-sales service if the problem persists.
13	Other battery alarms	Disconnect the AC output switch, DC input switch and Battery switch, then connect them 5 minutes later. Contact the dealer or the after-sales service if the problem persists.
14	Grid over voltage	<ol style="list-style-type: none"> <li>1. If the problem occurs occasionally, the utility grid may be abnormal temporarily. The inverter will recover automatically after detecting that the utility grid is normal.</li> <li>2. If the problem occurs frequently, check whether the grid voltage is within the permissible range. <ul style="list-style-type: none"> <li>• Contact the local power company if the grid voltage exceeds the permissible range.</li> <li>• Modify the overvoltage protection threshold, HVRT or disable the overvoltage protection function after obtaining the consent of the local power company if the grid frequency is within the permissible range.</li> </ul> </li> <li>3. Check whether the AC breaker and the output cables are connected securely and correctly if the problem persists.</li> </ol>
15	Grid under voltage	<ol style="list-style-type: none"> <li>1. If the problem occurs occasionally, the utility grid may be abnormal temporarily. The inverter will recover automatically after detecting that the utility grid is normal.</li> <li>2. If the problem occurs frequently, check whether the grid voltage is within the permissible range. <ul style="list-style-type: none"> <li>• Contact the local power company if the grid voltage exceeds the permissible range.</li> <li>• Modify the undervoltage protection threshold, LVRT or disable the undervoltage protection function after obtaining the consent of the local power company if the grid frequency is within the permissible range.</li> </ul> </li> <li>3. Check whether the AC breaker and the output cables are connected securely and correctly if the problem persists.</li> </ol>
16	Grid over current	<ol style="list-style-type: none"> <li>1. If the problem occurs occasionally, the utility grid may be abnormal temporarily. The inverter will recover automatically after detecting that the utility grid is normal.</li> <li>2. Contact the dealer or the after-sales service if the problem occurs frequently.</li> </ol>
17	Grid frequency abnormal	<ol style="list-style-type: none"> <li>1. If the problem occurs occasionally, the utility grid may be abnormal temporarily. The inverter will recover automatically after detecting that the utility grid is normal.</li> <li>2. If the problem occurs frequently, check whether the grid frequency is within the permissible range. <ul style="list-style-type: none"> <li>• Contact the local power company if the grid frequency exceeds the permissible range.</li> <li>• Modify the frequency protection threshold or disable the overfrequency protection function after obtaining the consent of the local power company if the grid frequency is within the permissible range.</li> </ul> </li> </ol>

18	DC bus over voltage	Disconnect the AC output switch, DC input switch and Battery switch, then connect them 5 minutes later. Contact the dealer or the after-sales service if the problem persists.
19	DC bus under voltage	Disconnect the AC output switch, DC input switch and Battery switch, then connect them 5 minutes later. Contact the dealer or the after-sales service if the problem persists.
20	PCS over temperature	<ol style="list-style-type: none"> <li>1. Check the ventilation and the ambient temperature at the installation point.</li> <li>2. If the ventilation is poor or the ambient temperature is too high, improve the ventilation and heat dissipation.</li> <li>3. Contact the dealer or after-sales service if both the ventilation and the ambient temperature are normal.</li> </ol>
21	PV over temperature	<ol style="list-style-type: none"> <li>1. Check the ventilation and the ambient temperature at the installation point.</li> <li>2. If the ventilation is poor or the ambient temperature is too high, improve the ventilation and heat dissipation.</li> <li>3. Contact the dealer or after-sales service if both the ventilation and the ambient temperature are normal.</li> </ol>
22	PVA over current	Disconnect the AC output switch, DC input switch and Battery switch, then connect them 5 minutes later. Contact the dealer or the after-sales service if the problem persists.
23	PVB over current	Disconnect the AC output switch, DC input switch and Battery switch, then connect them 5 minutes later. Contact the dealer or the after-sales service if the problem persists.
24	BuckBoost A over current	Disconnect the AC output switch, DC input switch and Battery switch, then connect them 5 minutes later. Contact the dealer or the after-sales service if the problem persists.
25	BuckBoost B over current	Disconnect the AC output switch, DC input switch and Battery switch, then connect them 5 minutes later. Contact the dealer or the after-sales service if the problem persists.
26	Battery side DC over voltage	<ol style="list-style-type: none"> <li>1. If the problem occurs occasionally, check battery input voltage, if it's within normal range, the inverter will recover automatically.</li> <li>2. Contact the dealer or the after-sales service if the problem occurs frequently.</li> </ol>
27	Battery side DC under voltage	<ol style="list-style-type: none"> <li>1. If the problem occurs occasionally, check battery input voltage, if it's within normal range, the inverter will recover automatically.</li> <li>2. Contact the dealer or the after-sales service if the problem occurs frequently.</li> </ol>

28	PVA over voltage	Check the serial connection of the PV array. Make sure that the open circuit voltage of the PV string is not higher than the maximum operating voltage of the inverter.
29	PVB over voltage	Check the serial connection of the PV array. Make sure that the open circuit voltage of the PV string is not higher than the maximum operating voltage of the inverter.
30	Ambient abnormal	<ol style="list-style-type: none"> <li>1. Check the ventilation and the ambient temperature at the installation point.</li> <li>2. If the ventilation is poor or the ambient temperature is too high, improve the ventilation and heat dissipation.</li> <li>3. Contact the dealer or after-sales service if both the ventilation and the ambient temperature are normal.</li> </ol>
31	Residual Current Fault	<ol style="list-style-type: none"> <li>1. If the problem occurs occasionally, it may be caused by a cable exception. The inverter will recover automatically after the problem is solved.</li> <li>2. Check whether the impedance between the PV string and PE is too low if the problem occurs frequently or persists.</li> </ol>
32	Hardware abnormal	Disconnect the AC output switch, DC input switch and Battery switch, then connect them 5 minutes later. Contact the dealer or the after-sales service if the problem persists.
33	Precharge abnormal	Disconnect the AC output switch, DC input switch and Battery switch, then connect them 5 minutes later. Contact the dealer or the after-sales service if the problem persists.
34	Insulation fault	<ol style="list-style-type: none"> <li>1. Check whether the resistance of the PV string to PE exceeds 50kΩ. If no, check the short circuit point.</li> <li>2. Check whether the PE cable is connected correctly.</li> <li>3. If the resistance is lower on rainy days, please reset the ISO.</li> </ol>
35	AC side relay abnormal	Disconnect the AC output switch, DC input switch and Battery switch, then connect them 5 minutes later. Contact the dealer or the after-sales service if the problem persists.
36	PVA Reverse Connection Fault	Check whether the PV strings are connected reversely.
37	PVB Reverse Connection Fault	Check whether the PV strings are connected reversely.

38	Hardware DC Bus Over Voltage	Disconnect the AC output switch, DC input switch and Battery switch, then connect them 5 minutes later. Contact the dealer or the after-sales service if the problem persists.
39	Hardware Battery Over Voltage	Disconnect the AC output switch, DC input switch and Battery switch, then connect them 5 minutes later. Contact the dealer or the after-sales service if the problem persists.
40	Grid 10 minutes Over Voltage	<ol style="list-style-type: none"><li>1. If the problem occurs occasionally, the utility grid may be abnormal temporarily. The inverter will recover automatically after detecting that the utility grid is normal.</li><li>2. If the problem occurs frequently, check whether the grid voltage is within the permissible range.<ul style="list-style-type: none"><li>• Contact the local power company if the grid voltage exceeds the permissible range.</li><li>• Modify the grid overvoltage rapid protection threshold after obtaining the consent of the local power company if the grid voltage is within the permissible range.</li></ul></li></ol>
41	EPS(Off-grid) Overload Fault	<ol style="list-style-type: none"><li>1. If the problem occurs occasionally, the EPS load may be abnormal temporarily. The inverter will recover automatically after few minutes.</li><li>2. If the problem occurs frequently, check whether the EPS load is within the permissible range.</li><li>3. Contact the dealer or the after-sales service if the problem persists.</li></ol>

## 10 Packaging, Transportation, Storage

- The system cabinet is packed in cardboard packaging and the internal PE packaging bag is moisture-proof and waterproof.
- Use EPE pearl cotton foam pad in the middle to prevent damage to the system during handling and transportation.
- Transportation must comply with UN3481's dangerous goods transportation and local laws and regulations.
- The system is heavy and must use the mechanical handling.
- Transportation temperature:  $-10^{\circ}\text{C} \sim 40^{\circ}\text{C}$ .
- The equipment and packaging cannot be sprayed, so it cannot be transported in the open air.
- Storage temperature:
  - ◆  $-20^{\circ}\text{C} \sim 35^{\circ}\text{C}$ , 12month;
  - ◆  $-20^{\circ}\text{C} \sim 45^{\circ}\text{C}$ , 3month;
  - ◆  $-20^{\circ}\text{C} \sim 55^{\circ}\text{C}$ , 1month;(The SOC before storage is kept in the range of 40% to 60%)
- Storage humidity: 0%~95%RH (No condensation)
- The storage room should be kept ventilated, the room should be clean and dry, and it should be protected from dust and moisture.
- The storage time can be up to 6 months. It is recommended to charge and discharge the system for more than the time.
- Prohibit direct sunlight on the device during storage.

## Annex 1: Hybrid Inverter Parameter Table

Model	HEC2-T15.0Hr2-Eu	HEC2-T12.0Hr2-Eu	HEC2-T10.0Hr2-Eu	HEC2-T8.0Hr2-Eu
<b>PV Input</b>				
Max. PV Array Power[W]	(7000+7000)/8500	(5500+5500)/7000	(5250+5250)/6000	(4250+4250)/5000
Max. Open Circuit Voltage[V]	1000	1000	1000	1000
Mppt Voltage Range[V]	180-950	180-950	180-950	180-950
Mppt Voltage Range at Full Load[V]	540-850	423-850	404-850	327-850
Max. Short Circuit Current(A/B)[A]	30/20	30/20	30/20	30/20
Max. Input Current(A/B)[A]	26/16	26/16	26/16	26/16
Start Operating Voltage[V]	200	200	200	200
No. of MPP Tracks/ String per MPP Tracker(A/B)	2/(2/1)	2/(2/1)	2/(2/1)	2/(2/1)
<b>BAT Input</b>				
Battery Voltage Range[V]	180-650			
Nominal Charge/Discharge Current[A]	30/30			
Communication Interfaces	RS485/CAN			
Reverse Connect Protection	Yes			
<b>AC Grid Input</b>				
Nominal AC Input Power[VA]	20000	20000	20000	16000
Max. AC Input Power[W]	20000	20000	20000	16000
Nominal AC Current[A]	27.8/29/30.3	27.8/29/30.3	27.8/29/30.3	22.2/23.2/24.3
Max. AC Current[A]	32	32	32	26
Nominal Apparent Power from Utility Grid (VA)	20000	20000	20000	16000
Max. Apparent Power from Utility Grid (VA)	20000	20000	20000	16000
Nominal Grid Voltage[V]	415/240~; 400/230~; 380/220V~; 3L/N/PE			
Nominal Grid Frequency[Hz]	50/60			
<b>AC Grid Output</b>				
Nominal AC Output Power[W]	15000	12000	10000	8000
Max. AC Output Power[W]	15000	13200	11000	8800
Max. Apparent Power to Utility Grid [VA]	15000	13200	11000	8800
Nominal Grid Voltage[V]	415/240~; 400/230~; 380/220V~; 3L/N/PE			
Nominal Grid Frequency[Hz]	50/60			
Max. Output AC Current[A]	24	20	16.7	13.3
Nominal Output AC Current[A]	21.7@230VAC	17.4@230VAC	14.5@230VAC	11.6@230VAC
Displacement Power Factor	-0.8~0.8			
THDi[%]	<3@Rated power			
<b>EPS(Off-grid) Output</b>				
Nominal EPS Ouput Power[W]	15000	12000	10000	8000
Max. EPS Output Apparent Power[VA]	15000	12000	10000	8000
Nominal Voltage[V]	230/400			

Frequency[Hz]	50/60			
Max Output Current[A]	24	19.3	16.1	12.9
Nominal Output Current[A]	21.7	17.4	14.5	11.6
Inrush Peak Current(A)	65	65	65	65
Switching from Grid Connected Mode to Standalone Mode[ms]	<20			
Switching from Standalone Mode to Network Connected Mode[ms]	>60s @VDE-AR-N 4105 2018-1			
THDv[%]	<3@Linear Load			
<b>EFFICIENCY</b>				
MPPT Max. Efficiency[%]	99.9			
Euro Efficiency[%]	96.1			
Max Efficiency[%]	97.7			
Battery Charge/Discharge Efficiency[%]	98.5(PV-BAT), 97(BAT-AC)			
<b>ENVIRONMENT LIMIT</b>				
Ingress Protection	IP65			
Protection Class	Class I			
Pollution Degree	PD3 (Outside)PD2 (Inside)			
Over Voltage Category	Over voltage category Mains III Over voltage category PV\Battery II			
Operating Temperature Range[° C]	-20~60(derating at 45)			
Max. Operation Altitude[m]	<3000			
Humidity	0-95%			
Storage Temperature[° C]	-40~70			
Typical Noise Emission[dBA]	<45			
Communication with BMS	CAN / RS485			
Communication with Meter	RS485			
Communication with Porta	RS485			
<b>DIMENSION AND WEIGHT</b>				
Dimension (W*H*D) [mm]	800(±2)*525(±2)*160(±2)			
Weight[KG]	52(±5)			
Cooling Concept	Smart Cooling			
Topology	Non-isolated			
Communication Interfaces	Meter/CT, CAN, RS485, WIFI(External)			
HMI	APP			
DC Connector(mm²)	4-6			
AC Connector(mm²)	6-10			



## Annex 2: Product Parameter Table

Model	HEC2-BHP100r2-EU	HEC2-BHP150r2-EU	HEC2-BHP200r2-EU	HEC2-BHP200r2-A-EU	HEC2-BHP300r2-A-EU	HEC2-BHP400r2-A-EU
Component	Base+BMS+2*Module	Base+BMS+3*Module	Base+BMS+4*Module	2*(Base+BMS+2*Module)	2*(Base+BMS+3*Module)	2*(Base+BMS+4*Module)
Nominal Voltage	204.8V	307.2V	409.6V	204.8V	307.2V	409.6V
Maximum Protection Voltage	233.6V	350.4V	467.2V	233.6V	350.4V	467.2V
Minimum Protection Voltage	179.2V	268.8V	358.4V	179.2V	268.8V	358.4V
Battery Module	Module*2	Module*3	Module*4	Module*4	Module*6	Module*8
Nominal Capacity	50Ah	50Ah	50Ah	100Ah	100Ah	100Ah
Total Energy	10.2kWh	15.3kWh	20.4kWh	20.4kWh	30.6kWh	40.8kWh
Nominal Power	5.12kW	7.68kW	10.24kW	10.24kW	15.36kW	20.48kW
Nominal Charge/Discharge Current	25A			50A		
Max. Charge/Discharge Current	30A			50A		
Cycle Life	6000 Cycles(@0.5C,90%DOD,25°C,60%SOH)					
Expected Life time	10 Years(60%SOH)					
Operating Ambient Temperature Range	-20°C to 55°C (derating above 45°C)					
Storage Temperature	-20°C to 55°C (1 months); -20°C to 45°C (3 months); -20°C to 35°C(1 year)					
Short Circuit Current	2.63kA, 1.072ms					
Over Voltage Category	OVC II					
Pollution Degree	PD3(external), PD2(internal)					
Humidity	0~95%					
Altitude	Below 2000m					
Protection	IP65					
System to Inverter	RS485/CAN2.0					
Battery to Battery/BMS	Daisy chain					
Display Interface	LED					
Switch on/off	Button*1+Breaker*1			2*(Base+BMS+2*Module)		
Certificate	CE, IEC62619, IEC62040, IEC60529, IEC61000, UN38.3					
Hazardous Materials Classification	Class 9					
Weight	124kg±6kg	179kg±8kg	234kg±10kg	248kg±12kg	358kg±16kg	468kg±20kg
External Dimensions (W*H*D)	800mm±20mm* 840mm±30mm* 160mm±20mm	800mm±20mm* 1150mm±30mm* 160mm±20mm	800mm±20mm* 1460mm±20mm* 160mm±20mm	1600mm±20mm* 840mm±30mm* 160mm±20mm	1600mm±20mm* 1150mm±30mm* 160mm±20mm	1600mm±20mm* 1460mm±30mm* 160mm±20mm
Remark	1 Series			2 Series Parallel		

### Annex 3: System Parameter Table

Model	HEC2-ESS-T 15/40r2-Eu	HEC2-ESS-T 15/30r2-Eu	HEC2-ESS-T 15/20r2A-Eu	HEC2-ESS-T 15/20r2-Eu	HEC2-ESS-T 15/15r2-Eu	HEC2-ESS-T 15/10r2-Eu
-------	--------------------------	--------------------------	---------------------------	--------------------------	--------------------------	--------------------------

#### PV Input Parameters

Maximum Input Power	14000/8500 W					
Maximum Input Voltage	1000 Vd.c.					
Rated Input Voltage	630 Vd.c.					
MPPT Voltage Range	180-950 Vd.c.					
MPPT Voltage Range (full load)	540-850 Vd.c.					
Maximum Input Current	26 Ad.c./16 Ad.c.					
Isc PV	30 Ad.c./20 Ad.c.					

#### Battery Input/Output Terminal Parameters

Battery Type	LFP					
Rated Voltage	409.6 V d.c.	307.2V d.c.	204.8V d.c.	409.6 V d.c.	307.2 V d.c.	204.8 V d.c.
Maximum Continuous Charging Current	30 A d.c.	30 A d.c.	30 A d.c.	25 A d.c.	25 A d.c.	25 A d.c.
Maximum Continuous Discharging Current	30 A d.c.	30 A d.c.	30 A d.c.	25 A d.c.	25 A d.c.	25 A d.c.
Nominal Capacity	100 Ah	100 Ah	100 Ah	50 Ah	50 Ah	50 Ah
Nominal Energy	40.8 kWh	30.6 kWh	20.4 kWh	20.4 kWh	15.3 kWh	10.2 kWh

#### Grid Input Terminal Parameters

Maximum Input Active Power	20 kVA					
Rated Input Voltage	3L/N/PE, 240/415, 230/400, 220/380 V a.c.					
Rated Continuous Input Current	27.8/29/30.3 A a.c.					
Maximum Continuous Input Current	32 A a.c.					
Rated Input Frequency	50/60 Hz					

#### Grid Output Rating

Rated Output Voltage	3L/N/PE, 240/415, 230/400, 220/380 V a.c.					
Rated Output Frequency	50/60 Hz					
Maximum Continuous Output Current	24 A a.c.					
Rated Output Power	15 kW					
Maximum Continuous Output Power	15 kW					
Rated Output Apparent Power	15 kVA					
Max. Output Apparent Power	15 kVA					
Power Factor	-0.8 to 0.8(default 1)					

#### EPS Output Rating

Rated Output Active Power	15 kW					
Rated Output Voltage	3L/N/PE, 230/400 V A.C.					
Rated Output Frequency	50/60 Hz					
Maximum Continuous Output Current	24 A a.c.					

**General**

Operating Temperature Range	-20°C to 55°C, >45°C Derating
Protective Class	Class I
Ingress Protection	IP65
Operating Altitude Range	<2000 m

Model	HEC2-ESS-T 12/40r2-Eu	HEC2-ESS-T 12/30r2-Eu	HEC2-ESS-T 12/20r2A-Eu	HEC2-ESS-T 12/20r2-Eu	HEC2-ESS-T 12/15r2-Eu	HEC2-ESS-T 12/10r2-Eu
-------	--------------------------	--------------------------	---------------------------	--------------------------	--------------------------	--------------------------

**PV Input Parameters**

Maximum Input Power	11000/7000 W
Maximum Input Voltage	1000 Vd.c.
Rated Input Voltage	630 Vd.c.
MPPT Voltage Range	180-950 Vd.c.
MPPT Voltage Range (full load)	423-850 Vd.c.
Maximum Input Current	26 Ad.c./16 Ad.c.
Isc PV	30 Ad.c./20 Ad.c.

**Battery Input/Output Terminal Parameters**

Battery Type	LFP					
Rated Voltage	409.6 V d.c.	307.2V d.c.	204.8V d.c.	409.6 V d.c.	307.2 V d.c.	204.8 V d.c.
Maximum Continuous Charging Current	30 A d.c.	30 A d.c.	30 A d.c.	25 A d.c.	25 A d.c.	25 A d.c.
Maximum Continuous Discharging Current	30 A d.c.	30 A d.c.	30 A d.c.	25 A d.c.	25 A d.c.	25 A d.c.
Nominal Capacity	100 Ah	100 Ah	100 Ah	50 Ah	50 Ah	50 Ah
Nominal Energy	40.8 kWh	30.6 kWh	20.4 kWh	20.4 kWh	15.3 kWh	10.2 kWh

**Grid Input Terminal Parameters**

Maximum Input Active Power	20 kVA
Rated Input Voltage	3L/N/PE, 240/415, 230/400, 220/380 V a.c.
Rated Continuous Input Current	27.8/29/30.3 A a.c.
Maximum Continuous Input Current	32 A a.c.
Rated Input Frequency	50/60 Hz

**Grid Output Rating**

Rated Output Voltage	3L/N/PE, 240/415, 230/400, 220/380 V a.c.
Rated Output Frequency	50/60 Hz
Maximum Continuous Output Current	20 A a.c.
Rated Output Power	12 kW
Maximum Continuous Output Power	13.2 kW
Rated Output Apparent Power	12 kVA
Max. Output Apparent Power	13.2 kVA
Power Factor	-0.8 to 0.8(default 1)

**EPS Output Rating**

Rated Output Active Power	12 kW
Rated Output Voltage	3L/N/PE, 230/400 V a.c.
Rated Output Frequency	50/60 Hz
Maximum Continuous Output Current	19.3 A a.c.

**General**

Operating Temperature Range	-20°C to 55°C, >45°C Derating
Protective Class	Class I
Ingress Protection	IP65
Operating Altitude Range	<2000 m

Model	HEC2-ESS-T 10/40r2-Eu	HEC2-ESS-T 10/30r2-Eu	HEC2-ESS-T 10/20r2A-Eu	HEC2-ESS-T 10/20r2-Eu	HEC2-ESS-T 10/15r2-Eu	HEC2-ESS-T 10/10r2-Eu
-------	--------------------------	--------------------------	---------------------------	--------------------------	--------------------------	--------------------------

**PV Input Parameters**

Maximum Input Power	10500/6000 W
Maximum Input Voltage	1000 Vd.c.
Rated Input Voltage	630 Vd.c.
MPPT Voltage Range	180-950 Vd.c.
MPPT Voltage Range (full load)	404-850 Vd.c.
Maximum Input Current	26 Ad.c./16 Ad.c.
Isc PV	30 Ad.c./20 Ad.c.

**Battery Input/Output Terminal Parameters**

Battery Type	LFP					
Rated Voltage	409.6 V d.c.	307.2V d.c.	204.8V d.c.	409.6 V d.c.	307.2 V d.c.	204.8 V d.c.
Maximum Continuous Charging Current	30 A d.c.	30 A d.c.	30 A d.c.	25 A d.c.	25 A d.c.	25 A d.c.
Maximum Continuous Discharging Current	30 A d.c.	30 A d.c.	30 A d.c.	25 A d.c.	25 A d.c.	25 A d.c.
Nominal Capacity	100 Ah	100 Ah	100 Ah	50 Ah	50 Ah	50 Ah
Nominal Energy	40.8 kWh	30.6 kWh	20.4 kWh	20.4 kWh	15.3 kWh	10.2 kWh

**Grid Input Terminal Parameters**

Maximum Input Active Power	20 kVA
Rated Input Voltage	3L/N/PE, 240/415, 230/400, 220/380 V a.c.
Rated Continuous Input Current	27.8/29/30.3 A a.c.
Maximum Continuous Input Current	32 A a.c.
Rated Input Frequency	50/60 Hz

**Grid Output Rating**

Rated Output Voltage	3L/N/PE, 240/415, 230/400, 220/380 V a.c.
Rated Output Frequency	50/60 Hz

Maximum Continuous Output Current	16.7 A a.c.
Rated Output Power	10 kW
Maximum Continuous Output Power	11 kW
Rated Output Apparent Power	10 kVA
Max. Output Apparent Power	11 kVA
Power Factor	-0.8 to 0.8(default 1)
<b>EPS Output Rating</b>	
Rated Output Active Power	10 kW
Rated Output Voltage	3L/N/PE, 230/400 V a.c.
Rated Output Frequency	50/60 Hz
Maximum Continuous Output Current	16.1 A a.c.
<b>General</b>	
Operating Temperature Range	-20°C to 55°C, >45°C Derating
Protective Class	Class I
Ingress Protection	IP65
Operating Altitude Range	<2000 m

Model	HEC2-ESS-T 8/40r2-Eu	HEC2-ESS-T 8/30r2-Eu	HEC2-ESS-T 8/20r2A-Eu	HEC2-ESS-T 8/20r2-Eu	HEC2-ESS-T 8/15r2-Eu	HEC2-ESS-T 8/10r2-Eu
-------	-------------------------	-------------------------	--------------------------	-------------------------	-------------------------	-------------------------

**PV Input Parameters**

Maximum Input Power	8500/5000 W
Maximum Input Voltage	1000 V d.c.
Rated Input Voltage	630 V d.c.
MPPT Voltage Range	180-950 V d.c.
MPPT Voltage Range (full load)	327-850 V d.c.
Maximum Input Current	26 Ad.c./16 Ad.c.
Isc PV	30 Ad.c./20 Ad.c.

**Battery Input/Output Terminal Parameters**

Battery Type	LFP					
Rated Voltage	409.6 V d.c.	307.2V d.c.	204.8V d.c.	409.6 V d.c.	307.2 V d.c.	204.8 V d.c.
Maximum Continuous Charging Current	30 A d.c.	30 A d.c.	30 A d.c.	25 A d.c.	25 A d.c.	25 A d.c.
Maximum Continuous Discharging Current	30 A d.c.	30 A d.c.	30 A d.c.	25 A d.c.	25 A d.c.	25 A d.c.

**Grid Input Terminal Parameters**

Maximum Input Active Power	16 kVA
Rated Input Voltage	3L/N/PE, 240/415, 230/400, 220/380 V a.c.
Rated Continuous Input Current	22.2/23.2/24.3 A a.c.

Maximum Continuous Input Current	26 A a.c.
Rated Input Frequency	50/60 Hz
<b>Grid Output Rating</b>	
Rated Output Voltage	3L/N/PE, 240/415, 230/400, 220/380 V a.c.
Rated Output Frequency	50/60 Hz
Maximum Continuous Output Current	13.3 A a.c.
Rated Output Power	8 kW
Maximum Continuous Output Power	8.8 kW
Rated Output Apparent Power	8 kVA
Max. Output Apparent Power	8.8 kVA
Power Factor	-0.8 to 0.8(default 1)
<b>EPS Output Rating</b>	
Rated Output Active Power	8 kW
Rated Output Voltage	3L/N/PE, 230/400 V a.c.
Rated Output Frequency	50/60 Hz
Maximum Continuous Output Current	12.9 A a.c.
<b>General</b>	
Operating Temperature Range	-20°C to 55°C, >45°C Derating
Protective Class	Class I
Ingress Protection	IP65
Operating Altitude Range	<2000 m

# HICONICS

A member of Midea group

**HICONICS ECO-ENERGY DRIVE TECHNOLOGY CO., LTD.**

---

No.3 Boxing 2nd Road, Economic and Technological Development Zone  
100176 Beijing P.R.China

Tel: +86 10 5918 0033 Email: [hiconics\\_service@midea.com](mailto:hiconics_service@midea.com)

Web://[www.hiconics-global.com](http://www.hiconics-global.com)